

Cooling capacity performance curves
PFB 43.000 IP 54

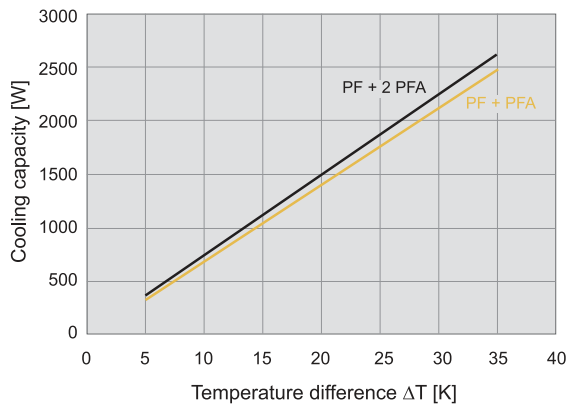

Static pressure performance curves
PFB 43.000 IP 54

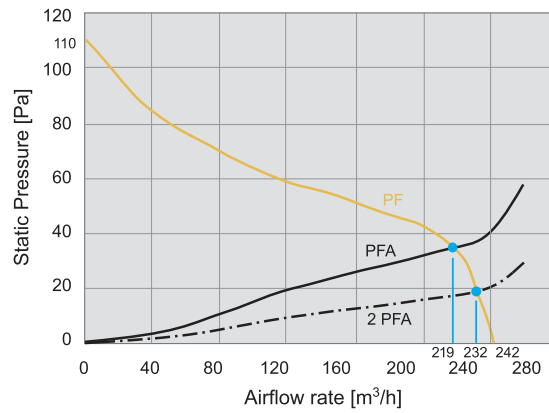

Dimensions

mm	PFB 43.000	PFBA 40.000
X	252	252
Y	252	252
Z1	6	6
Z2	113	38
A'	223	223
B'	223	223

¹ for material thicknesses up to 2 mm
+1 mm for thickness of material > 2 mm ≤ 3 mm

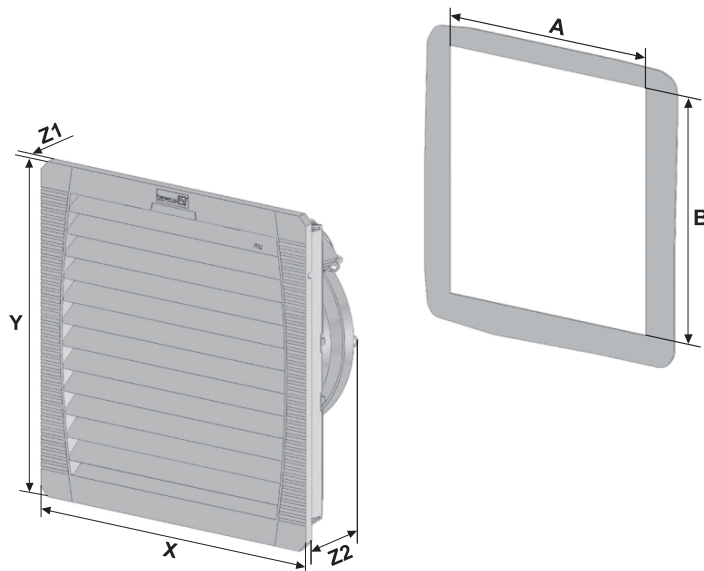

IP 55 Filter fans available on request