

Cooling capacity performance curves

PFB 66.000 IP 54

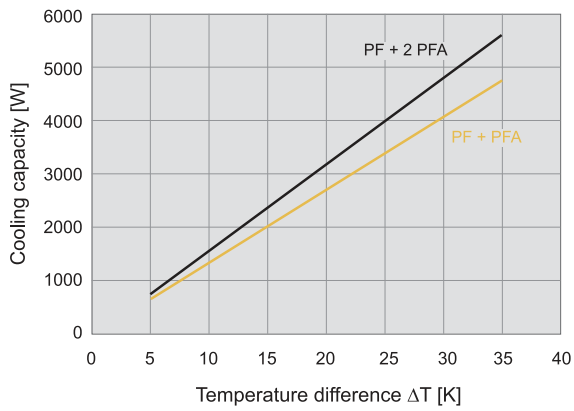

Static pressure performance curves

PFB 66.000 IP 54

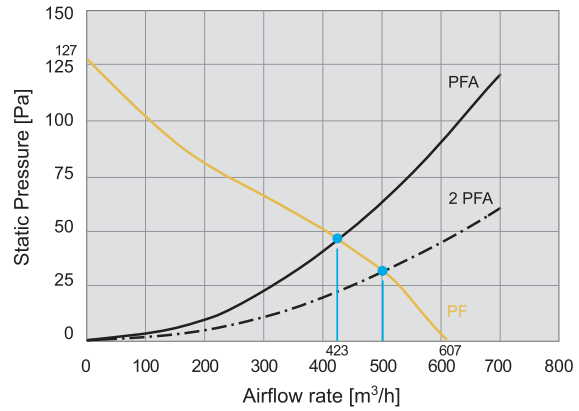

Dimensions

mm	PFB 66.000	PFBA 60.000
X	320	320
Y	320	320
Z1	7	7
Z2	150	39
A'	291	291
B'	291	291

¹ for material thicknesses up to 2 mm
+1 mm for thickness of material > 2 mm ≤ 3 mm

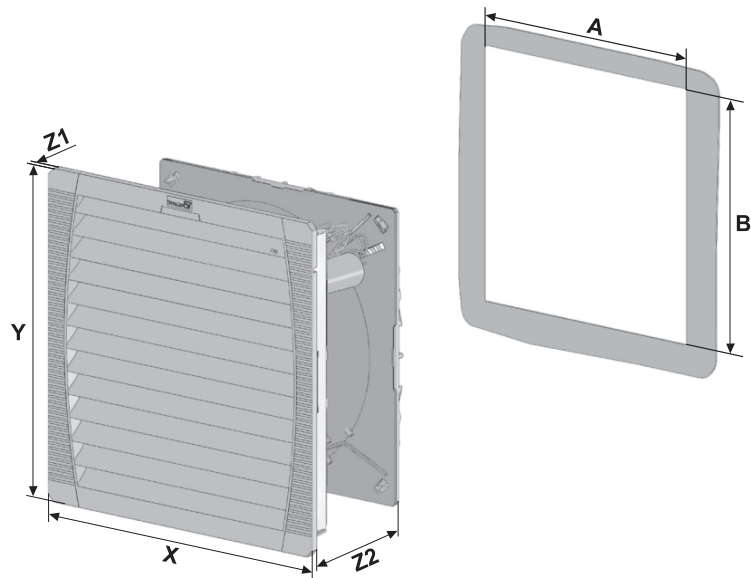

IP 55 Filter fans available on request