

嵌入式机柜空调操作及使用说明书

DTI 8361 50/60 Hz 系列

Operating and assembly instruction

For side-mounted cooling units

DTI 8361 50/60 Hz

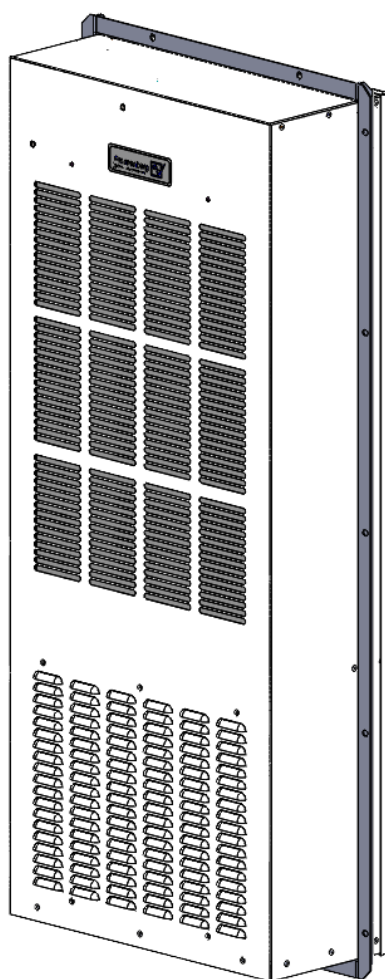

1 手册提示.....	8
2 搬运.....	8
2.1 运输.....	8
2.2 储运.....	8
2.3 开箱.....	8
3 供货范围.....	9
4 一般信息.....	9
5 铭牌.....	9
6 安全.....	10
7 功能.....	10
7.1 配置与功能.....	10
7.2 工作原理.....	10
7.3 冷凝物.....	11
8 技术规格书.....	12
8.1 电气原理图.....	12
8.2 备品备件.....	13
8.3 安装开孔.....	13
8.4 气流原理.....	16
8.5 技术参数.....	17
9 安装.....	18
9.1 概述.....	18
9.2 安装工作.....	18
9.3 电气连接.....	19
10 运行条件.....	20
11 投入使用和功能.....	20

11.1 概述.....	20
11.2 操作显示器.....	21
11.3 启动测试模式.....	21
11.4 门触点.....	21
11.5 设备故障.....	21
12 参数查看与设置.....	22
12.1. 参数查看.....	22
12.2. 参数设置.....	22
12.3. 恢复出厂设置.....	24
12.4. 远程设置.....	25
13 清洁和维护.....	25
13.1 清洁.....	25
13.2 维护.....	25
14 停止使用.....	25
15 回收.....	26
16 故障排除.....	26
17 保障条款.....	27
附表 I.....	28
附表 II.....	28
1 Hints on the manual.....	30
2 Handling.....	30
2.1 Transport.....	30
2.2 Storage.....	30
2.3 Unpacking.....	31
3 Scope of delivery and options.....	31
4 General Information.....	31

5	Name plate	31
6	Safety	32
7	Function.....	32
	7.1 Function and configuration	32
	7.2 Operating principles.....	32
	7.3 Condensate.....	33
8	Technical data	34
	8.1 Circuit Diagram.....	34
	8.2 Spare parts	35
	8.3 Installation Cut-out.....	35
	8.4 Airflow principle	37
	8.5 Technical Data	38
9	Installations	39
	9.1 General.....	39
	9.2 Installation work	39
	9.3 Electrical connection.....	40
10	Operating condition.....	41
11	Putting into operation and function	41
	11.1 General remarks	41
	11.2 Operation display	42
	11.3 Start-up / Test mode	42
	11.4 Door contact	42
	11.5 Equipment fault	43
12	Parameters View and Settings	43
	12.1. View Parameters	43
	12.2. Parameter setting	43

12.3. Reset factory default setting	45
12.4. Remote settings	46
13 Cleaning and Maintenance	46
13.1 Cleaning	46
13.2 Maintenance	47
14 When not in used	47
15 Recycle.....	47
16 Trouble shooting.....	47
17 Warranty Conditions.....	49
Appendix I.....	49
Appendix II.....	49



请在安装机组前完整仔细阅读此手册。
本手册构成标准产品不可分割的一部分，必须保存至机组报废为止

1 手册提示

此手册为百能堡电气科技有限公司（以下简称百能堡）提供的门装或侧装螺栓固定，外挂式机柜空调系列的安装运行指南。

本手册中，安全提示和其他信息以下形式出现：

警告

如果没有严格遵守所述的措施，将有生命危险或造成健康危害。

危险

如果没有严格遵守所述的措施，将可能因电击造成生命或健康危害。

注意

如果没有严格遵守所述的措施，将有可能造成生命财物损失。

提示

提示包含关于所述措施或指导的额外信息。

2 搬运

2.1 运输

- 请通过壳体或吊环来提升机柜空调。
- 运输时保持机柜空调处于最终使用时相同的摆放状态。
- 如果整体机柜需要运输，请在运输前将机柜空调拆下并单独包装。

不按照这些指导操作，将导致保障条款失效。

2.2 储运

- 储存环境不应超过70°C。
- 储存时使机组处于最终使用时的摆放状态。

不按照这些指导操作，将导致保障条款失效。

2.3 开箱

开箱过程中应当仔细查看机柜空调，看是否存在因运输造成的破坏，尤其注意是否有部件松动、凹坑、擦伤和漏油等。任何损坏应当立即通知承运商（[见保障条款](#)），并且适用“百能堡产品售后服务声明”的最新版本。

- 在处理包装材料前，务必确认里面没有任何附加部件。



机组的钣金件边缘有可能残留金属毛刺，在维护或安装时务必带保护手套。
要求保障时，需要提供故障的确切信息（如有可能请提供照片），机种型号和序列号。

3 供货范围

供货范围包括：

- 机柜空调
- 附件包（包括紧固件，插头式电气连接器等）
- 特殊的附件（如适用）

4 一般信息

- 百能堡可以妥善处理旧设备,但客户需承担运输费用.
- 百能堡生产的机柜空调不含以下物质:
 - 多氯三联苯
 - 石棉
 - 甲醛
 - 镉
 - 液态有害物质
- 对每台机柜空调进行检查以确保它是完全依照9.ProdSV的规定（德国事故预防法规）。
- 交货前百能堡已对每台空调在工厂进行电气安全检测。

5 铭牌

安装和维护，请注意机器背部铭牌标注的详细技术信息。

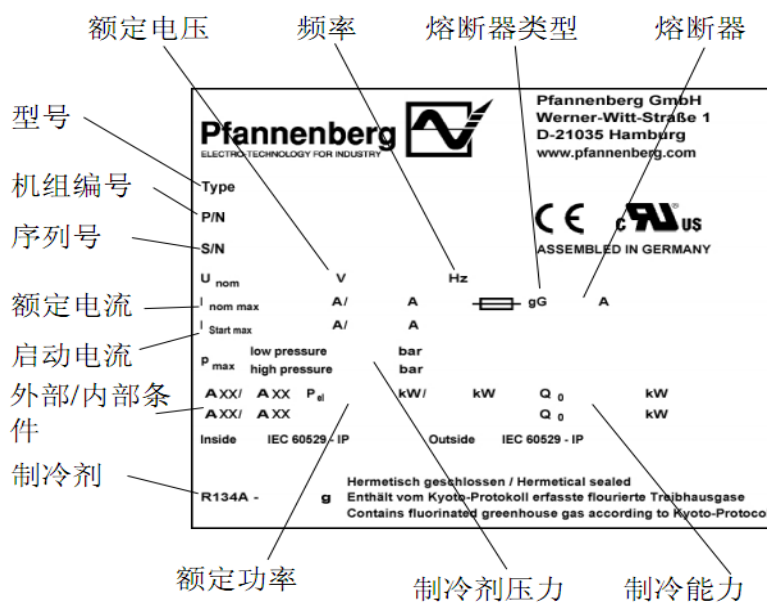

6 安全

- 由百能堡生产的机柜空调是专为机柜散热（IP55）而设计的。
- 该设备只适合在固定地点平稳运行。
- 任何其他使用范围被视为非授权使用，并将不作保修承诺。电气设备应定期检查。任何异常如连接松脱或烧焦的电缆必须被立即修复。
- 只有专业技术人员才能对热交换系统和电气部件进行操作。
- 请务必遵守相应的安全和环保法规。



危险

任何清洁或维护操作之前，需切断机柜空调电源。
只有原厂备件可以使用。

7 功能

7.1 配置与功能

- 1) $-40^{\circ}\text{C} \sim +55^{\circ}\text{C}$ 环境温度
- 2) 内部控制温度 $+18^{\circ}\text{C} \sim +43^{\circ}\text{C}$
- 3) 机柜内部加热器1000W（可选）
- 4) IP55/IP34防护
- 5) RS485通讯



注意

机柜空调的具体功能见技术规格书（[见章节8](#)）。

7.2 工作原理

压缩机（1）将制冷剂压缩到高压。在这个过程中温度升高。冷凝器（2）中，热量散失到周围环境空气中，制冷剂变成液体。冷凝器风扇（5）吸入并使空气通过冷凝器，然后排放出去。在截流装置（3）中，冷却液的压力下降。在蒸发器（4）中，冷却剂吸收机柜内空气中的热量并蒸发。因此，来自机柜中的空气被冷却下来；同时机柜内的空气被除湿。蒸发器风（6）吸出机柜内的空气并迫使其通过蒸发器，冷却空气吹回到机柜内。机柜空调是由电子系统控制的。温度传感器（7）记录了机柜内的空气温度。所使用制冷剂不损害臭氧层，而且不可燃。

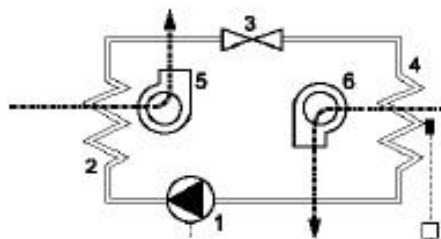

7.3 冷凝物

在蒸发器上发生的冷却过程中，空气中的水分被凝聚成冷凝水。为了避免对电控柜及本制冷系统发生任何损害，必须排出冷凝水。

冷凝水排放方式如下：

- 带冷凝水蒸发器（可选）的制冷设备在正常情况下，可以蒸发掉水分。但为防止蒸发器故障后产生的冷凝水溢流，请连接冷凝水管路，然后再通过水管排出。始终确保冷凝水正确地排出。在特定情况下有可能会发生凝结水过量，例如，机柜不密封或机柜内部温度经常低于露点温度。



在正常运行过程中发生冷凝水过量,请检查机柜的密封。

我们建议安装一个门接触开关，当机柜门被打开时,机柜空调将自动关闭,以防止过度冷凝水。

8 技术规格书

8.1 电气原理图

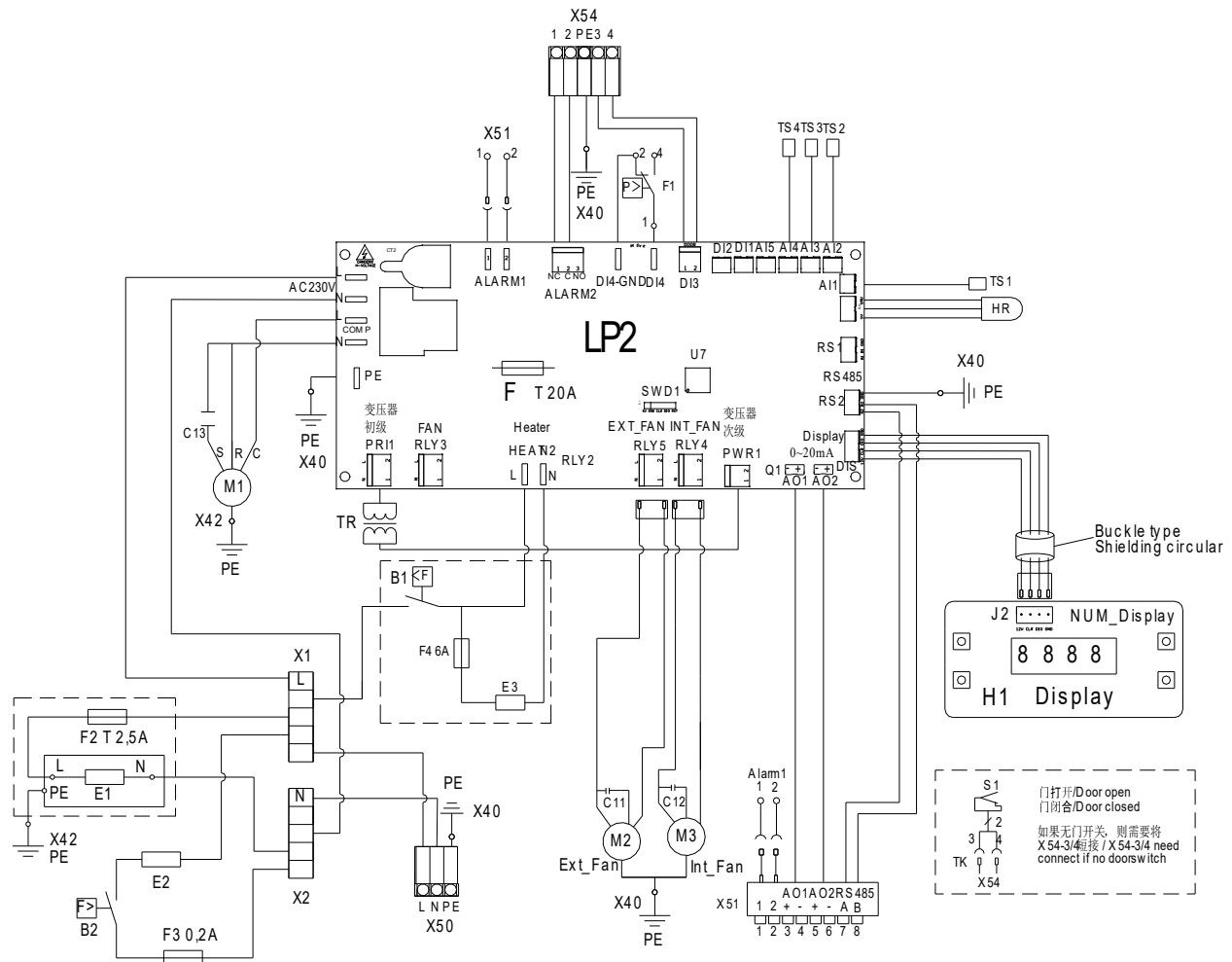

B1/B2	温控器
C11	电容-冷凝器风扇
C12	电容-蒸发器风扇
C13	电容-压缩机
E1	冷凝水蒸发器
E2	加热带
E3	加热器
F1	高压开关
F2/F3/F4	熔断器
H1	指示器
TR	变压器
LP2	线路板
M1	压缩机
M2	冷凝器风扇

M3	蒸发器风扇
S1	门禁开关
TK	门触点
TS1/TS2/TS3/TS4	温度探头
HR	湿度探头
X1/X2	5线连接器
X40/X41/X42/PE	接地
X50	电源连接
X54-1,2	设备故障信号
X54-3,4	门禁信号
X51-1,2	电源故障信号
X51-3,4	温度模拟量输出
X51-5,6	湿度模拟量输出
X51-7,8	RS485
[]	可选

8.2 备品备件

(请使用百能堡物料号来采购备用件)

备用件	DTI 8361
内风机	
外风机	
压缩机	
内风机电容	
外风机电容	
压缩机电容	
干燥过滤器	
控制器	18865500060 (主板) 18865500061 (显示器) 此备件物料号会贴在主板和显示器上

8.3 安装开孔

DTI 8361
密封泡棉粘贴效果图

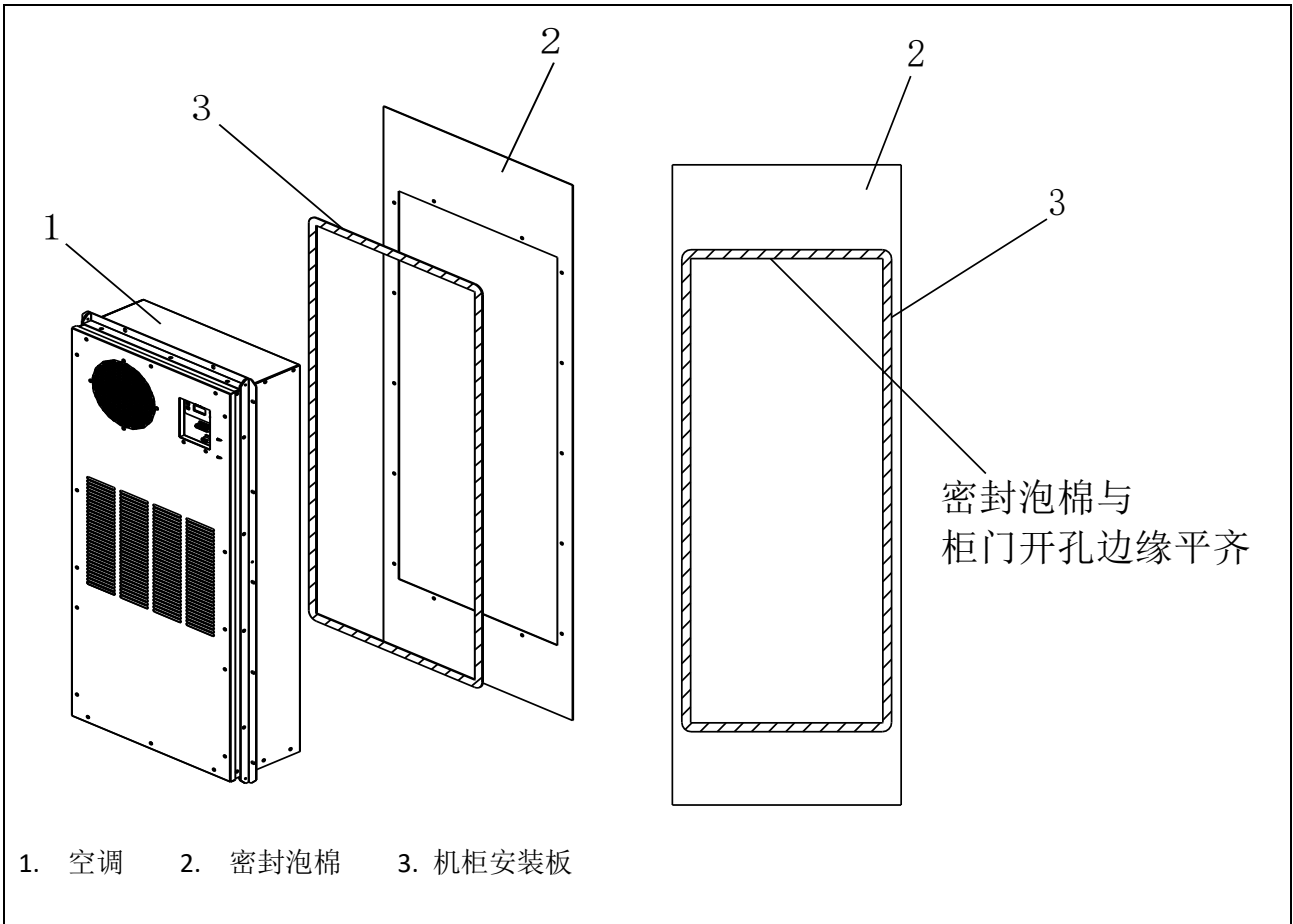

DTI 8361 安装开孔

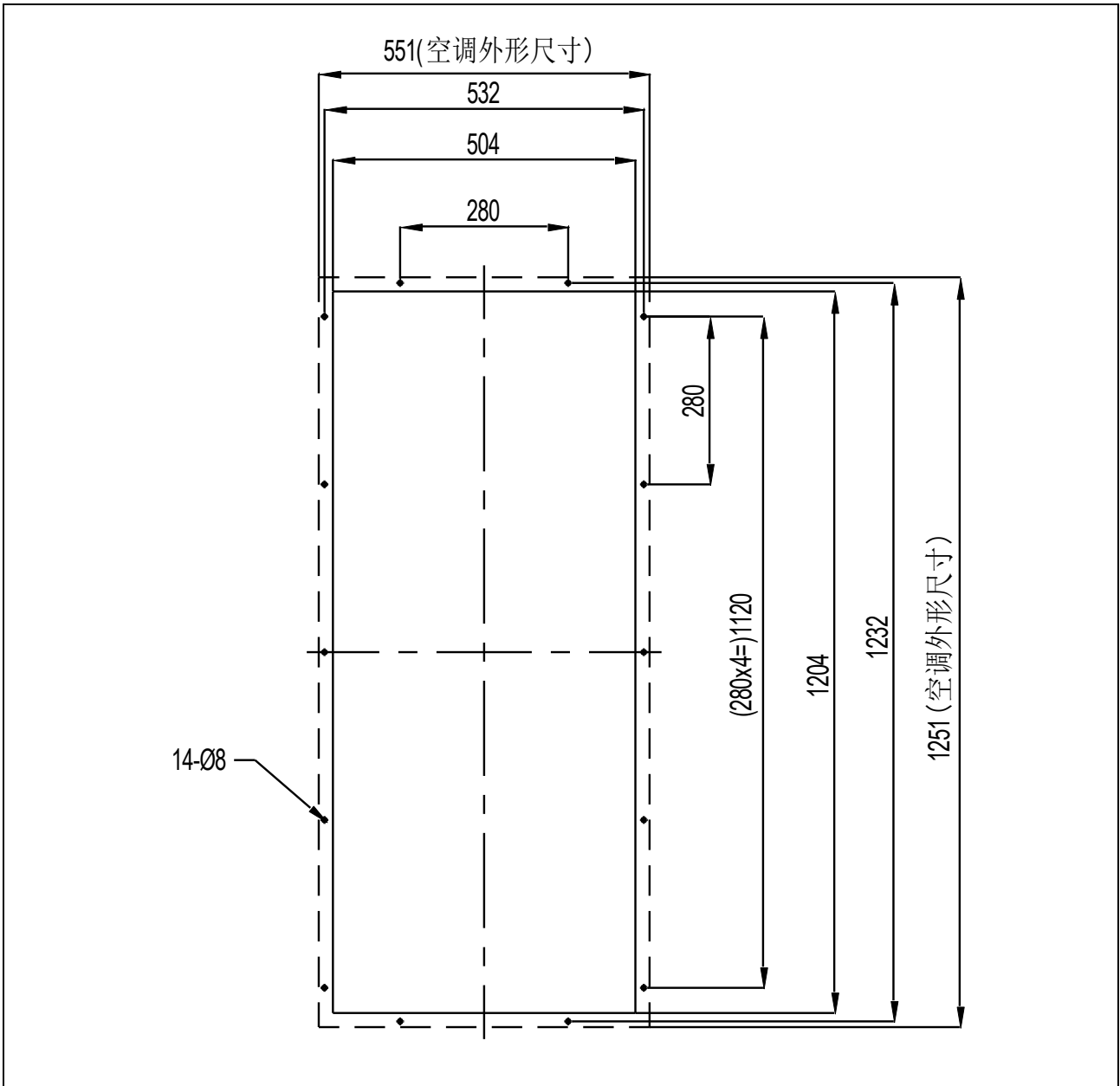

8.4 气流原理

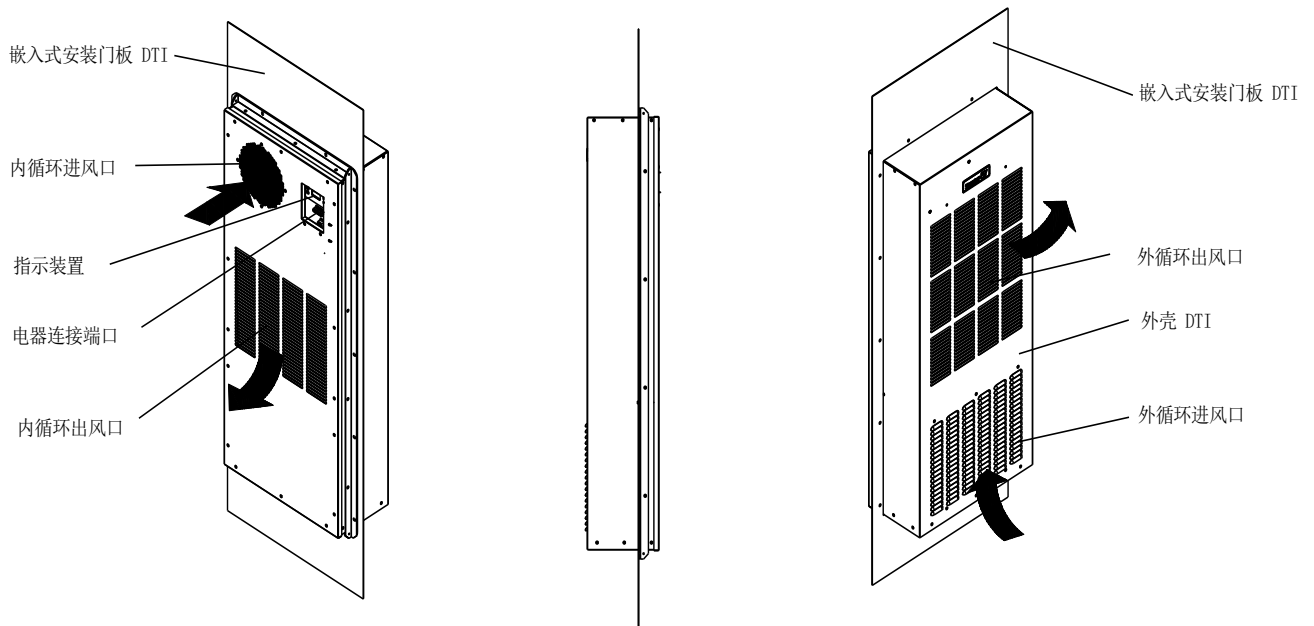

⚠ 注意

在安装此设备前应当完整仔细地阅读此说明。此说明是设备不可分割的一部分，在设备报废前请务必保留。
安装前，请确认设备间以及设备至墙体的距离至少有 200 毫米的间距；在柜子内部的进风口以及出风口没有干涉以及障碍。

8.5 技术参数

性能		DTI 8361
制冷能力 A35/A35 * **	Q 0	3000 / 3200 W
制冷能力 A50/A35 * **	Q 0	2150 / 2300 W
冷媒 *		R 134a
冷媒量*		1420 g
温控 (工厂设置)		+33° C (+91.4° F)
内部温度报警指示 (工厂设置)		> +45° C (+113° F)
环境温度		-40° C (-40° F) . . . +55° C (+131° F)
内部温度		+18° C (+64.4° F) . . . +43° C (+109.4° F)
外循环气流量 °)		1200 m ³ /h
内循环气流量 °)		1600 m ³ /h
冷凝水排放		冷凝水管
噪音 (1m)		≤ 68 dB(A)
电气数据		
电源频率		50 /60 Hz
工作范围		DIN IEC 60038
额定电压		230 V
电力消耗 * (A35/A35):	P el	1250 / 1570 W
电流 *	I nom max	8,5 / 11,7 A
启动电流 *	I Start max	40,0 A
加热量		1000 W @ 0°C (可选)
尺寸		
高 X 宽 X 深 ° °)		1251 x 551 x 225 (mm)
重量		66 kg
安装状态		垂直
结构		标准: 钢板
防腐处理		标准: 镀锌, 静电喷粉
防护等级		IP 55 对机柜 (EN 60529), 正确安装操作为前提. IP 34 对环境 (EN 60529), 正确安装操作为前提.

* 铭牌信息,

**无过滤网 (可选) 情况下制冷量

°)自由送风

°°)空调电器接口处另需电器端子空间40mm

9 安装

9.1 概述

- 正确选择机柜空调在机柜上的安装位置,保证良好的通风。
- 机柜空调之间或是机柜空调和墙壁的距离必须保证至少200毫米。
- 在机柜内部, 空调的电器连接端子处需预留至少40mm空间。
- 在机柜内部, 电气元件不得阻碍空气循环。
- 机柜空调在安装时, 机柜空调的电源必须断开!
- 安装现场必须受到保护, 免遭污染。

⚠ 注意

如果机柜空调是装在机柜门上, 必须检查门的铰链能够支持机柜空调的重量或当门被打开机柜时, 不会翻倒。

⚠ 注意

金属碎屑可能损坏机柜。如果在安装现场开安装孔, 确保使用保护罩, 以免切屑进入机柜, 损坏电气元件。

9.2 安装工作

机柜安装面要开好空气通风口和螺栓安装固定孔, 尺寸根据开孔尺寸。

- 1) 如机柜未预留机柜空调的开口, 在机柜上切出开口(尺寸见[开孔尺寸](#)), 然后去除剪边毛刺。
- 2) 取出附件包内密封条(标号3), 并对齐贴在门板开口外侧(标号2)。
- 3) 取出附件包内的平垫片、弹垫、螺母(标号4、5、6)在机柜内侧将空调锁紧。
- 4) 将电线按照接线图(见机柜空调背部)连接到连接头(附件包中), 并连接到机柜空调(见[章节9.3](#))。

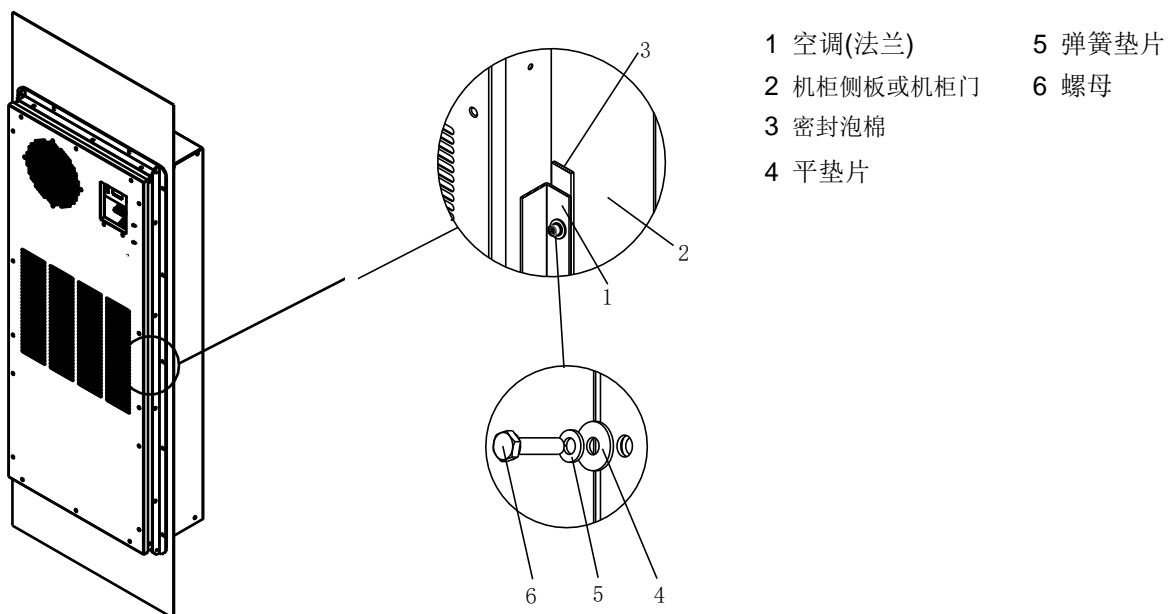

9.3 电气连接

⚠ 注意

- 机柜空调应当经由断路器连接到电源（请选择合适的断路器），断开断路装置时,其触点间隙应不少于3毫米。
- 电源线上不可以串接温度传感器。
- 电源线上需要串接铭牌注明的保险丝,作为线路保护。
- 电源连接和维修，如果适用，只能由授权的经过培训的电工来进行。

电源连接:

电源电压和频率必须符合铭牌标示值。请认真查看机器上有更多带有解释的标签。

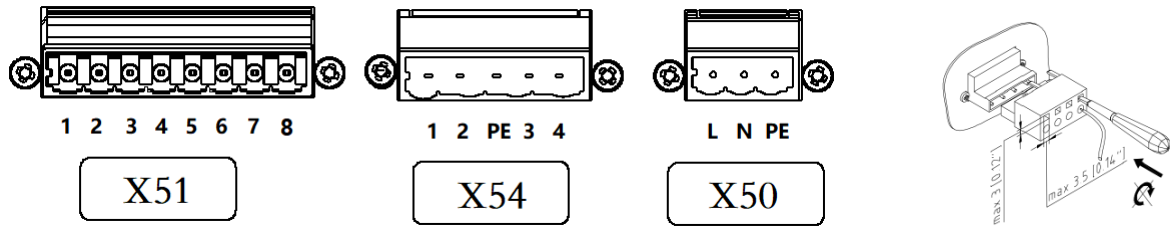

电气端口	序号	符号	定义	导线尺寸
X50	L	L	交流电源火线	Max 2.5mm ² / AWG14
	N	N	交流电源零线	
	PE	PE	交流电源地线	
X54	1	/	设备故障告警信号	Max 1.0mm ² / AWG18
	2	/		
	PE	PE	门禁地线	
	3	/	门禁控制触点	
4	/			
X51	1	/	电源故障告警信号	Max 1.0mm ² / AWG18
	2	/		
	3	A01 +	4~20mA 温度模拟量输出正极	
	4	A01 -	4~20mA 温度模拟量输出负极	
	5	A02 +	4~20mA 湿度模拟量输出正极	
	6	A02 -	4~20mA 湿度模拟量输出负极	
	7	RXD+	RS485 通讯端口正极	
8	TXD-	RS485 通讯端口负极		

⚠ 注意

电源电压和频率必须符合铭牌标示值，请认真查看机器上的电气标签。如果电压过高可能会导致器件损坏；一般空调的额定电压230V。

通讯连接:

机柜空调支持标准的Modbus规约RTU模式，出厂默认通讯地址：“1”，波特率：“9.6Kbps”。

RS-485从设备端口最多允许32台设备利用双绞线通讯电缆通过菊花型连接方式组成通讯网络。

为了将多台空调连接成菊花型网络形式，应采用以下方法：

- 将屏蔽线在主机端一点接地即可，最后一台机柜空调需匹配接120欧姆的电阻。
 - 为了避免任何破坏性的影响，建议使用一根带有护线套的双绞电缆线。
 - 在安装过程中必须确保它们不会被附近的潜在干扰源影响（如电源线，具有相对较高的电磁辐射的器件）
- 将每台空调的+、- 端子一一对应的连接起来，如下图所示：

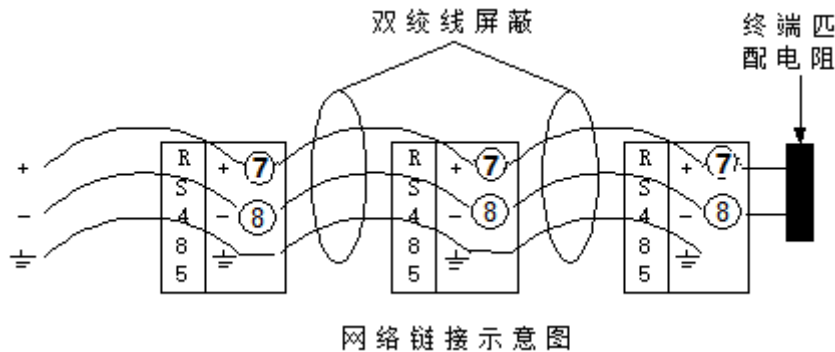

警告

请按照线路图接线，错误的接线将导致设备无法正常工作甚至损坏！

10 运行条件

- 电压范围为额定电压的 $230\text{V} \pm 10\%$ 以内。
- 电源频率为额定频率的 $\pm 3\text{Hz}$ 以内。
- 环境温度必须低于 55°C 。
- 使用本机时注意使热交换量适合实际的需求。
- 只使用原装备件。

11 投入使用和功能

- 机柜空调包含的功能及可选项 [见章节 7](#)。

11.1 概述

- 机柜空调配有温度控制系统。机柜内部温度通过温度传感器来测量。通过操作显示器可以设定不同的机柜内温度（[见附表II](#)）。
- 机柜空调具有上电检测、运行时实时监测功能。上电检测过程中如果有故障，空调会发出相应的报警，这使得在进入工作模式之前更方便的排查设备故障。

11.2 操作显示器

机柜空调装有操作显示器。上电后操作显示器显示柜内实时温度，表明机组在正常操作模式。如果发生故障或有报警输出时，操作显示器显示报警代码，这使诊断机柜空调故障更容易（见章节16）。

11.3 启动测试模式

通电前，若门触点断开，则机柜空调不启动，直到门触点闭合后，机柜空调进入自测试模式，自测试模式将不受外部环境影响。机柜空调上电后进入启动模式，持续约30s，之后进入自测试模式，持续约120秒；自测试模式过程中有故障则设备停止运行并产生相应的报警代码，所有故障则需解除故障后，方可进入正常工作模式；如无故障直接进入正常工作模式。

模式	时间曲线	特征
启动模式	t=0-30s	显示内部温度
自测试模式	t=30-40s	内风机运行
	t=40-50s	内风机停止，外风机运行
	t=50-60s	外风机停止，加热器运行
	t=60-90s	加热器停止，压缩机运行
	t=90-150s	内风机、外风机、加热器，压缩机一起运行

11.4 门触点

确保安全门限位开关应连接到指定端口（见机壳上线路图或电气原理图）当打开机柜门时门触开关即被断开，机柜空调所有设备延时60s依次关闭停止工作，之后产生门禁断开报警。

注意

为了避免任何破坏性的影响，建议使用一根带护线套的双绞线电缆。

无需另接外部电源。

如果门触点开关未被使用，需将其短接方可启用空调运行。（位置见机壳标签或电气原理图）

11.5 设备故障

机柜空调设备故障告警触点X54—1,2脚上电后无故障为闭合，有故障时将引起故障触点断开并显示告警代码（见章节16）。

机柜空调电源故障报警触点X51—1,2脚为常闭触点，上电后无电源故障为闭合，有电源故障时将引起触点断开并显示告警代（见章节16）。

注意

故障触点连接最大容量为：230V，1A

12 参数查看与设置

- 机柜空调可以通过操作显示器对参数进行监控或设置（显示器代码层级关系见附表 I）。
- 机柜空调电子控制系统包括主控制系统、操作显示系统，面板上的指示灯从左到右排列的功能含义如下表：

指示灯	指示灯含义	长亮
	上电自检	自检
	制冷	正在制冷
	制热	正在制热
	除湿	正在除湿
	风机	风机运转
	告警	告警发生



12.1. 参数查看

操作面板主界面下，长按“Select”键 3s，当操作显示器显示 SEE 时，再按“Select”键，然后通过“▼”或“▲”键循环切换选择参数“ts1”、“t1”、“Hs1”、“U”、“SC”、“add”、“bau”、“Ao1”、“Ao2”、“no1”、“no2”、“no4”、“no5”、“no6”、“no7”、“CC”，选中任意代码后按“Select”键，进入其相应参数的参数值，按“Mode”键可返回上层菜单。在任意操作界面的菜单下连续按 Mode”键或静置 3min 无任何操作，可返回到主显示界面。具体代码意义详见（附表 II）。

12.2. 参数设置

- 操作面板主界面下，长按“Select”键 3s，当操作显示器显示 SEE，然后通过按“▼”或“▲”键，选择“PASS”然后按“Select”键进入密码输入界面，默认显示数值 000，可通过按“▲”键输入数值，按“▼”键移位数值输入，输入密码“666”后，按“Select”键确认进入：用户一级菜单。（一级菜单与对应二级菜单见附表 I）

- 一级菜单操作：可使用“▲”或“▼”键循环选择，温度“tP”、湿度“Hr”、Modbus“Co”、报警状态“AL”、电源“Po”、模式状态“Sta”、设备状态“dg”、模拟量“Ag”、使能“En”、历史告警记录“HS”。当选择相应的一级菜单后按“Select”进入对应的二级菜单，在对应的二菜单里通过用“▲”或“▼”键可循环选择观察各参数。

- 二级菜单的操作：进入对应的二级菜单后按“Select”键可查看或设置其参数值。当弹出具体数值为闪烁状态时表示其参数为可设置，若修改其数值需按“▲”键输入新的数值，按“▼”键移位数值，输入调整到合适的数值后再次按“Select”键进行保存修改；如果不需要修改对应的菜单参数值，只需按“Mode”键即可取消操作并

返回上层菜单；任意操作过程中按 Mode” 键可返回到上层菜单，中途连续按 Mode” 键或静置 3min 无任何操作，则会自动返回到主显示界面。（附表 II）

- 内部目标温度 “t1” 操作设置步骤：

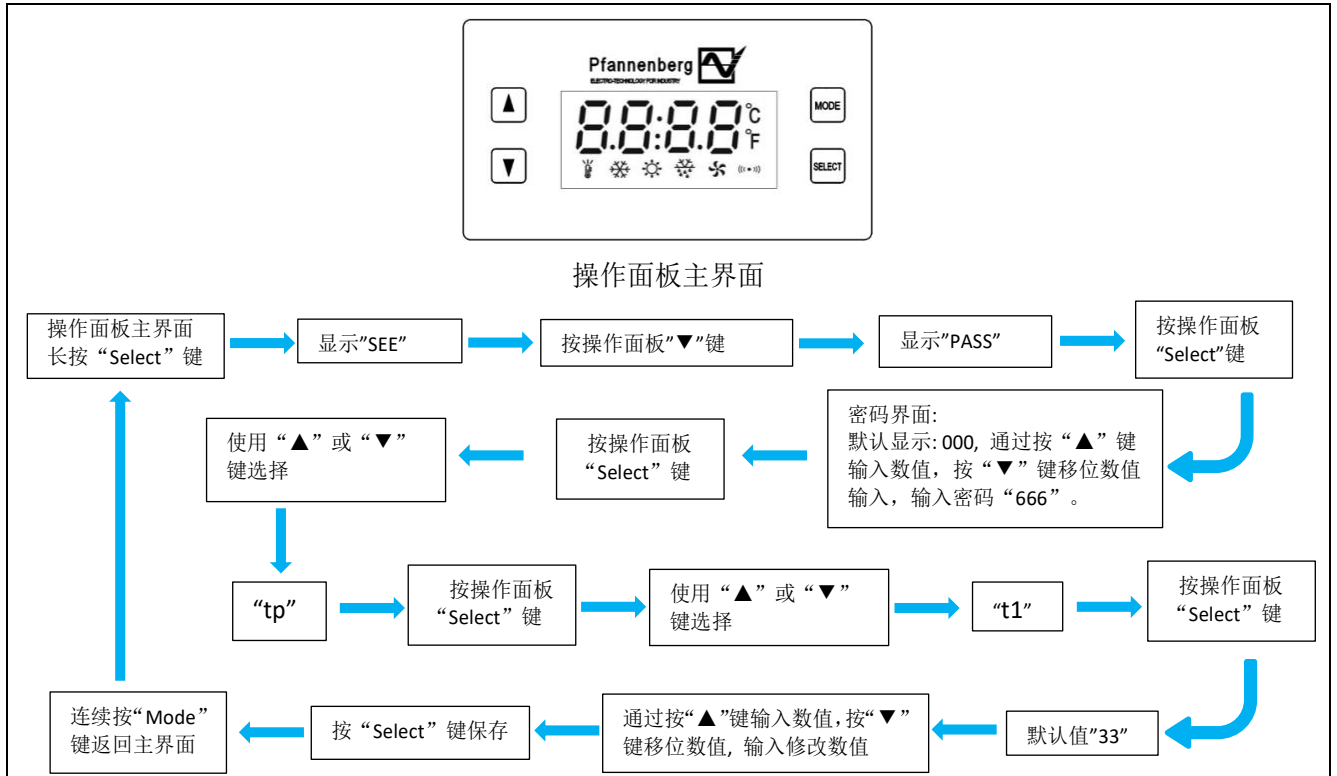

- 通讯地址 “add” 操作设置步骤:

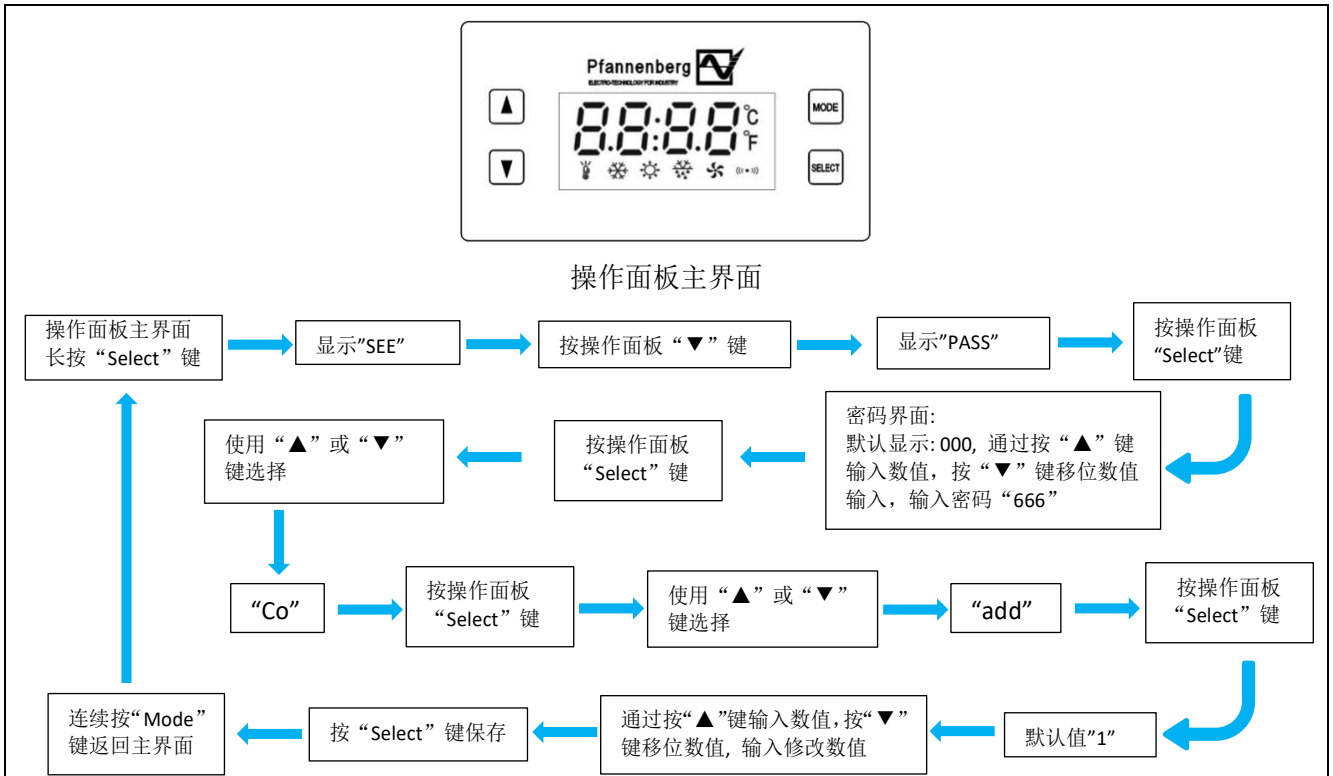

• 示例中在任意操作过程若需取消操作或返回上层级菜单只需按“Mode”键即可，连续按Mode”键或静置3分钟无任何操作则会返回到主显示界面。

• 二级菜单（附表 I）涉及的其他参数的修改可参照示例“t1”，“add”修改设置操作方法，在进入对应的一级菜单后进行操作设置

警告

参数设置应遵循附表 II 及其备注规定，不正确的设置将导致机器不能正常工作！

注意

在任意操作画面下，无任何按键触发时，180 秒后将返回到主界面。

12.3. 恢复出厂设置

操作面板主界面下，长按“Select”键 3s，当操作显示器显示 SEE，然后通过按“▼”或“▲”键，选择到 dEFu 菜单，然后按“Select”键进入密码输入界面，默认显示数值 000，可通过按“▲”键输入数值，按“▼”键移位数值输入，输入密码***，按“Select”键确认恢复出厂设置完成；连续按“Mode”键可返回主界面。

注意

恢复出厂设置密码，请咨询我们的 Pfannenberg 服务团队（www.pfannenberg.com）

恢复出厂设置后请断电重启机柜空调，设备提供最多存储 200 个历史报警记录，当恢复出厂设置后，历史报警也相应清除。

12.4. 远程设置

机柜空调支持标准的 Modbus 规约 RTU 模式，参数的设置也可以通过上位机软件远程访问或设置。（通讯地址参数见附表 II）。

13 清洁和维护



危险

在任何清洁或维护操作前，请切断空调电源。

13.1 清洁

建议每个月对机柜空调进行维护，例如对冷凝回路进行清洗，将提高设备的运转效率以及可靠性。具体维护周期视使用环境而定。

特别注意以下说明：

- 清洗外部风道，冷凝器以及外风机。
- 用软刷或高压空气进行作业。（注意不要伤到翅片）

步骤如下：

- 1) 断开机柜空调电源。
- 2) 打开外壳。
- 3) 清洁风道。
- 4) 清洁外风机。
- 5) 清洁交换器。
- 6) 装回外壳
- 7) 接通电源并观察上电自检，确保设备运转正常。



注意

防止电气元件漏电。不要使用任何尖锐或锋利的物体。

防止热交换器损坏。

防止外罩电气连接损坏。在拆卸外罩时，应当手动拔去外罩里面的电气连接。安装时，不要忘插上该电气连接！

13.2 维护

设备出现故障后，会自动提示故障代码，故障代码对应的故障原因见章节 16。

每一次维护后，请等待设备上电自检结束，以确保设备能够正常运转。

14 停止使用

如果机柜空调在较长时间内未被使用，请切断电源。确保未经授权的人员不会擅自启动空调。

机柜空调需要报废处理时，需根据相关环保法规由专业人员进行处理。（见章节 4）

15 回收



注意

- 必须由具备相应资质的专业技术人员执行拆卸作业；另外还须了解本地规定及法规。
- 所有零件（例如，制冷剂、油、金属、电子元件）必须予以回收、再利用或丢弃。请遵守本地和国家的各项规定及法规并在必要时联系本地垃圾清理行业。
- 丢弃上述垃圾时，必须咨询专业垃圾清理公司，由该公司出具垃圾清理证明，该证明必须归档；丢弃时，请咨询我们的 Pfannenberg 服务团队（参见 www.pfannenberg.com/disposal）



16 故障排除

尽管有精心维护,还是有可能产生故障。机柜空调的实时自检功能能够准确的自行诊断设备故障。

如果机器发生故障，操作显示器显示相关报警代码，用户可根据下表中的报警代码查找，使得诊断更容易。

报警列表：

报警代码	描述	故障排除方法
AL1	ts1 告警	1) 检查感温头 Pb1 2) 检查连接线是否损坏 3) 检查接头是否插错位
AL2	ts2 告警	1) 检查感温头 Pb2 2) 检查连接线是否损坏 3) 检查接头是否插错位
AL3	ts3 告警	1) 检查感温头 Pb3 2) 检查连接线是否损坏 3) 检查接头是否插错位
AL4	ts4 告警	1) 检查感温头 Pb4 2) 检查连接线是否损坏 3) 检查接头是否插错位
AL5	湿度传感器故障	1) 检查湿度传感器 2) 检查连接线是否损坏 3) 检查接头是否插错位
AL6	机柜门打开	1) 检查门开关触点是否闭合 2) 检查接线是否松动 3) 检查接线是否接错
AL7	系统压力过高	1) 检查外部风道是否阻塞 2) 检查风机是否运转正常 3) 检查冷凝器是否脏堵，并清洁冷凝器外表面。 4) 检查压力传感器连接线

AL8	超温告警	<ol style="list-style-type: none"> 1) 检查内部热负荷 2) 检查内部风机运转是否正常 3) 检查设备制冷是否启动 4) 检查内部控制设定参数是否在合理范围
AL9	低温告警	<ol style="list-style-type: none"> 1) 检查加热器是否启动 2) 检查内部风机运转是否正常 3) 检查内部控制设定参数是否在合理范围
AL10	高湿告警	<ol style="list-style-type: none"> 1) 湿度过高，检查机柜密封 2) 检查湿度传感器接线
AL11	低湿告警	<ol style="list-style-type: none"> 1) 湿度过低 2) 检查湿度传感器接线
AL12	压缩机故障	<ol style="list-style-type: none"> 1) 检查压缩机连接线路 2) 检查制冷系统是否正常 3) 检查参数设置是否在合理范围
AL13	蒸发器脏堵或内循环风口堵塞	<ol style="list-style-type: none"> 1) 检查内循环风道有无堵塞 2) 检查蒸发器表面是否清洁
AL14	蒸发器结霜	<ol style="list-style-type: none"> 1) 检查内部热负荷 2) 检查内部风机运转是否正常 3) 检查内循环风道是否堵塞 4) 检查设定参数是否在合理范围
AL15	电源电压故障	<ol style="list-style-type: none"> 1) 检查设备供电电源电压

警告

非授权人员不可检修此设备

17 保障条款

以下情况保障将失效：

- 机组的不恰当使用，不适宜的运行条件或不遵守操作指导；
- 在腐蚀或酸性空气环境下使用；
- 由脏污或脏堵的过滤垫造成的损坏；
- 非授权人员擅动温度控制回路，改动机组或更改机组序列号；
- 由运输或是事故造成的损坏；
- 由非授权组织更换部件；

为了维护您的质保权益，在退回机组时请遵守以下规定：

- 在包装中附上确切的故障描述。
- 附上发货单（百能堡发货单或发票复印件）。
- 随机将所有附件退回；使用原始包装或同规格的包装，运输时先垫付运费及足够的运输保险。

遵守[章节 2](#)提到的运输提示

附表 I

显示器代码层级关系						
一级代码	二级代码	名称	一级代码	二级代码	名称	
(tP) 温度	tS1	内循环入风口温度	(Sta) 模式状态	AU	内部预留, 请勿修改参数 (否则将导致设备不能正常工作)	
	tS2	内循环出口温度		CL		
	t1	内部温度设定		Ht		
	t2	节能温度设定		FA		
	t5	加热器设定温度		SD		
	t6	加热回差		DH		
	t8	柜内温度过高点		d3		高压开关
	t9	柜内温度过低点		d4		门开关
(Hr) 湿度	HS1	柜内湿度	(dg) 开关量	StS	设备工作状态	
	rh1	除湿开启点		no1	内风机	
	rh2	除湿回差		no2	外风机	
(Co) 通讯	add	通讯地址		no4	加热器	
	baU	波特率		no5	压缩机	
(aL) 报警	no6	故障报警		Ao1	温度模拟量输出	
	no7	电源报警		Ao2	湿度模拟量输出	
(Po) 电源	U	总电压		(en) 使能	Eco	内部预留, 请勿修改参数 (否则将导致设备不能正常工作)
	Sc	总电流	CC			
(hS) 历史警报	E1-E200	告警代码	Edh			

附表 II

通讯地址:

地址 (10 进制)	显示器代码	数据类型	R/W 说明	功能码	描述	默认值	值范围	单位	数据说明
1	ts1	Analog	R	03	内循环入风口温度			℃	实际值*10 上传
2	ts2	Analog	R	03	内循环出口温度			℃	实际值*10 上传
3	ts3	Analog	R	03	蒸发温度			℃	实际值*10 上传
4	ts4	Analog	R	03	冷凝温度			℃	实际值*10 上传
5	Hs1	Analog	R	03	柜内湿度			%	实际值*1 上传
6	Ao1	Analog	R	03	温度模拟量输出电流			mA	实际值*10 上传
7	Ao2	Analog	R	03	湿度模拟量输出电流			mA	实际值*10 上传
8	U	Analog	R	03	总电压			V	实际值*1 上传
9	SC	Analog	R	03	总电流			A	实际值*10 上传
10	t1*	Analog	R/W	03/06	内部温度设定	33	20-45	℃	实际值*10 上传
12	t3	Analog	R/W	03/06	制冷停止回差	2	1-10	℃	实际值*10 上传
14	t5	Analog	R/W	03/06	加热器设定温度	10	-40-35	℃	实际值*10 上传
15	t6	Analog	R/W	03/06	加热回差	5	2-15	℃	实际值*10 上传
16	t7	Analog	R/W	03/06	除湿制冷中间变量	5	1-10	℃	实际值*10 上传
17	t8*	Analog	R/W	03/06	柜内温度过高点	45	25-70	℃	实际值*10 上传
18	t9	Analog	R/W	03/06	柜内温度过低点	0	-20-20	℃	实际值*10 上传
20	rH1	Analog	R/W	03/06	除湿开启点	80	70-99	%	实际值*1 上传
21	rH2	Analog	R/W	03/06	除湿回差	20	10-30	%	实际值*10 上传
22	rHH	Analog	R/W	03/06	湿度过高点	85	60-100	%	实际值*1 上传
23	rHL	Analog	R/W	03/06	湿度过低点	20	0-30	%	实际值*1 上传
24	add*	Integer	R/W	03/06	地址	1	1-255		实际值*1 上传
25	baU*	Integer	R/W	03/06	波特率	3	0-5		0=1200, 1=2400, 2=4800, 3=9600, 4=19200, 5=38400
32	no6	Boolean	R	03	故障报警				00 正常, 01 报警
33	no7	Boolean	R	03	电源信号				00 正常, 01 报警
42	d3	Boolean	R	03	高压开关				0=断开, 1=闭合
43	d4	Boolean	R	03	门开关				0=断开, 1=闭合
44	STS	Boolean	R	03	设备工作状态				0=停止, 1=运行
45	no1	Boolean	R	03	内风机				0=停止, 1=运行
46	no2	Boolean	R	03	外风机				0=停止, 1=运行
47	no3	Boolean	R	03	预留风机				0=停止, 1=运行
48	no4	Boolean	R	03	加热器				0=停止, 1=运行
49	no5	Boolean	R	03	压缩机				0=停止, 1=运行
55	AL 1	Boolean	R	03	传感器 ts1 故障				00 正常, 01 报警
56	AL 2	Boolean	R	03	传感器 ts2 故障				00 正常, 01 报警
57	AL 3	Boolean	R	03	传感器 ts3 故障				00 正常, 01 报警

58	AL 4	Boolean	R	03	传感器 ts4 故障				00 正常, 01 报警
59	AL 5	Boolean	R	03	湿度传感器故障				00 正常, 01 报警
60	AL 6	Boolean	R	03	机柜门打开报警				00 正常, 01 报警
61	AL 7	Boolean	R	03	系统压力过高报警				00 正常, 01 报警
62	AL 8**	Boolean	R	03	高温报警				00 正常, 01 报警
63	AL 9	Boolean	R	03	低温告警				00 正常, 01 报警
64	AL 10	Boolean	R	03	湿度过高报警				00 正常, 01 报警
65	AL 11	Boolean	R	03	湿度过低报警				00 正常, 01 报警
66	AL 12	Boolean	R	03	压缩机故障报警				00 正常, 01 报警
67	AL 13	Boolean	R	03	蒸发器脏堵或内循环风口堵塞报警				00 正常, 01 报警
68	AL 14	Boolean	R	03	ts3 低温报警				00 正常, 01 报警
69	AL 15	Boolean	R	03	电源电压故障				00 正常, 01 报警
74	ALARM	Integer	R	03	实时警告				实际值*1 上传
75	HISAL1	Integer	R	03	最近一次历史告警				实际值*1 上传
76	HISAL2	Integer	R	03	次近一次历史告警				实际值*1 上传
79	HISAL200	Integer	R	03	第 200 次历史告警				实际值*1 上传

注意

- * 为内部设定温度可修改设定值, 机柜冷却器有2℃回差, 默认内部设定温度为33℃, 高于35℃开始制冷, 内部温度31℃以下时停止制冷。不建议修改其它参数, 不正确的修改将导致机器无法工作。
- ** 默认当内部温度高于 45℃时,设备将产生高温报警; 如果温度下降到“t1”+ 5℃以内时高温告警消失。请设置告警温度高于柜内设置温度至少 5℃。
- *** 默认加热器启动设置为内部温度低于5℃时启动, 当内部温度高于10℃时停止加热。

警告

所有附表参数请误擅自更改, 不按照百能堡的指导操作将导致产品保障条款失效。
 所有未提及参数为百能堡预留, 最终使用及解释权归百能堡所有。
 所有未提及参数请勿擅自更改, 否则设备将不能正常工作。



Read this manual completely and carefully before installing the unit.
This manual is an integral part of the product and must be kept until is Disposed.

1 Hints on the manual

This handbook contains instructions for the installation and operation of door or side-mounted, bolt-on Cooling Units provided by Pfannenberg.

In this manual, safety recommendations and other information are structured as follows.

WARNING

If the measures described in the following are not strictly observed there is danger to life and health.

DANGER

If the measures described in the following are not strictly observed there is danger to life and health due to electrical shock.

CAUTION

If the measures described in the following are not strictly observed material damage may be caused.

NOTE

A hint contains additional information on the action or instruction described.

2 Handling

2.1 Transport

- Lift the cooling unit only by the enclosure or with two eyebolt rings
- Transport the cooling unit only in condition of usage.
- Prior to transport remove the cooling unit and pack it separately if the complete switch cabinet is to be transported.

Failure to observe these instructions will render the warranty provisions null and void.

2.2 Storage

- Never expose cooling units to temperatures exceeding +70 °C during storage.
- Store cooling unit only in condition of usage.

Failure to observe these instructions will render the warranty provisions null and void.

2.3 Unpacking

- During unpacking make a visual inspection of the cooling unit to see whether any damage has occurred during transport. Especially pay attention to loose parts, dents, scratches, visible loss of oil etc. Any damage must be reported immediately to the forwarding agent ([also refer to warranty](#)). Moreover, the latest edition of the "Pfannenberg After Sales Service Declaration" shall apply.
- Before disposing of packing material ensure that it does not contain any loose components.



Burr caused by production may be present on the metal edges of the unit. Always wear protective gloves when carrying out maintenance work and installation.

In case of a warranty claim exact details on the fault (photograph, if possible) and the indication of type and serial number of the cooling unit are required.

3 Scope of delivery and options

The Scope of delivery includes:

- Cooling unit
- Enclosed package (among other things, fastening material, electrical plug-type connectors)
- Quick guide
- Special accessories, if applicable

4 General Information

- Old devices can be properly disposed of by Pfannenberg. They must be sent to one of our works shipment/postage paid.
- All cooling units produced by Pfannenberg are free from
 - PCT
 - Asbestos
 - Formaldehyde
 - Cadmium
 - Substances impairing wetting.
- Every cooling unit is checked to ensure that it is tight according to the provisions of 9.ProdSV (German regulations covering accident prevention).
- Pfannenberg has done electrical safety testing to every cooling before delivery.

5 Name plate

For the installation and maintenance, please take note of the technical data on the name plate which can be found on the back of the cooling unit.

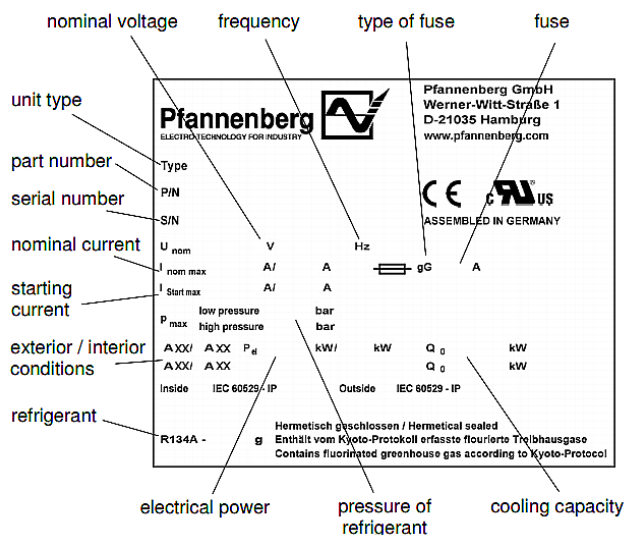

6 Safety

Cooling units produced by Pfannenberg are designed for use in dissipating heat from switch cabinets (IP 55).

The cooling unit is only suitable for installing on the stationary operation.

Only the authorized specialist can work on the cooling system and electrical components.

Please make sure to comply with relevant safety and environmental regulations.



Switch off cooling unit power supply before carrying out any cleaning or maintenance operations.

Only original spare parts may be used.

7 Function

7.1 Function and configuration

1. General external environment temperature: -40°C~+55°C
2. Internal temperature control range: +18°C~+43°C
3. PTC Heater 1000W (Optional)
4. IP55 internal / IP34 external protection class
5. Communication RS 485

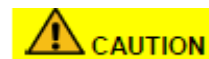

Please refer to technical data for the detailed function of the cooling unit. ([see Section 8](#))

7.2 Operating principles

The compressor (1) compresses the refrigerant until high pressure is achieved. During this process temperature increases. In the condenser (2) heat is dissipated to ambient air, the coolant becoming liquid. The condenser fan (5) takes ambient air in through the condenser, and then it releases the air. In the expansion

valve (3) the pressure of the coolant drops. In the evaporator (4) the coolant absorbs heat from the air in the switch cabinet and evaporates. Thus, the air in the switch cabinet cools down. At the same time the air inside the switch cabinet is being dehumidified. The evaporator fan (6) sucks the air out of the switch cabinet via the evaporator, the cooled air flows back to the switch cabinet.

The cooling unit is electronically controlled. For that purpose a temperature sensor records the temperature of the air inside the switch cabinet (7).

The refrigerant is not detrimental to the ozoneosphere; it is hardly combustible.

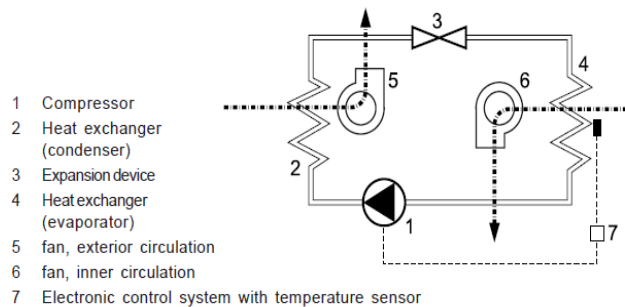

7.3 Condensate

During cooling, the moisture removed from the hot air by the evaporator is collected as condensate. In order to avoid any damage to the switch cabinet and the cooling unit, the condensate must be discharged.

The condensate is discharged in the following way:

In case of normal condensate drainage a reservoir (option) collects the condensate which is then drained by means of a hose.

Always ensure that the condensate is drained properly (safety- drainage).

Excessive condensation can occur if, for example, the switch cabinet is not sealed or if the internal temperature of the switch cabinet is frequently below the dew point.

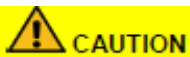

Please check the sealing of the switch cabinet, if there is excessive condensate during the normal operation.

In order to prevent the excessive condensate we recommend to install a door contact switch. It will switch off the cooling unit when the switch cabinet door is open.

8 Technical data

8.1 Circuit Diagram

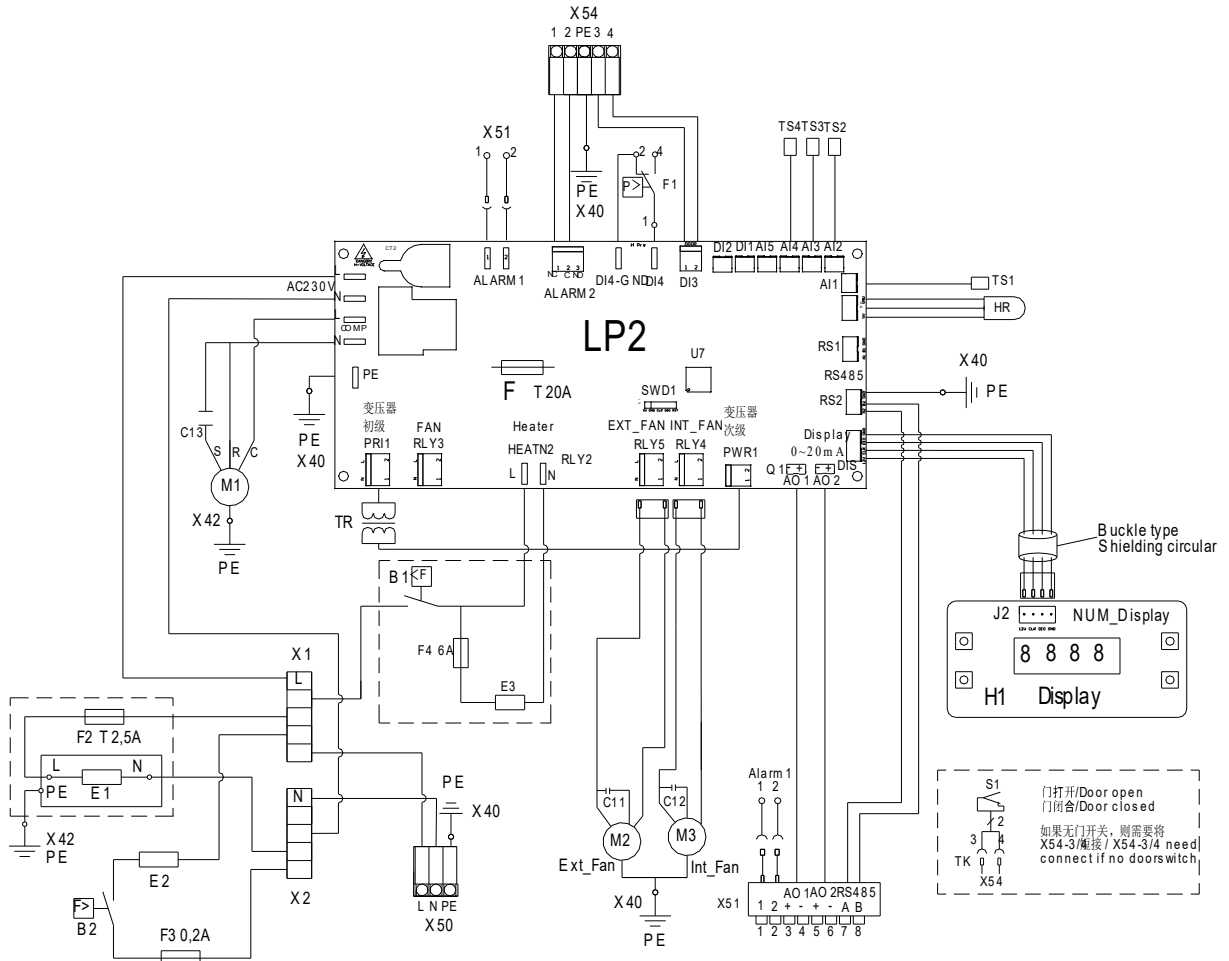

B1/B2	Thermostat	M3	Evaporator fan
C11	Capacitors-condenser fan	S1	Door contact
C12	Capacitors-evaporator fan	TK	Door contact
C13	Capacitors-compressor	TS1/TS2/TS3/TS4	Temperature sensor
E1	Condensate evaporation	HR	Humidity probe
E2	Crankcase heater	X1/X2	5 wires connector
E3	Heater	X40/X41/X42/PE	Earthing connection
F1	High pressurestat	X50	Connection mains
F2/F3/F4	Fuse	X54-1,2	Device faultsignal
H1	Operating indicator	X54-3,4	Door contact
TR	Transformer	X51-1,2	Power faultsignal
LP2	PCB	X51-3,4	Temperature analogue output
M1	Compressor	X51-5,6	Humidity analogue output
M2	Condenser fan	X51-7,8	RS485 connection communication
		[]	Option

8.2 Spare parts

Please order your spare parts only with the Pfannenberg-parts-number.

Spare parts	DTI 8361
Internal fan	
External fan	
Compressor	
Internal fan Capacitor	
External fan Capacitor	
Compressor Capacitor	
Filter Dryer	
Controller	Part number is located on the controller'

8.3 Installation Cut-out

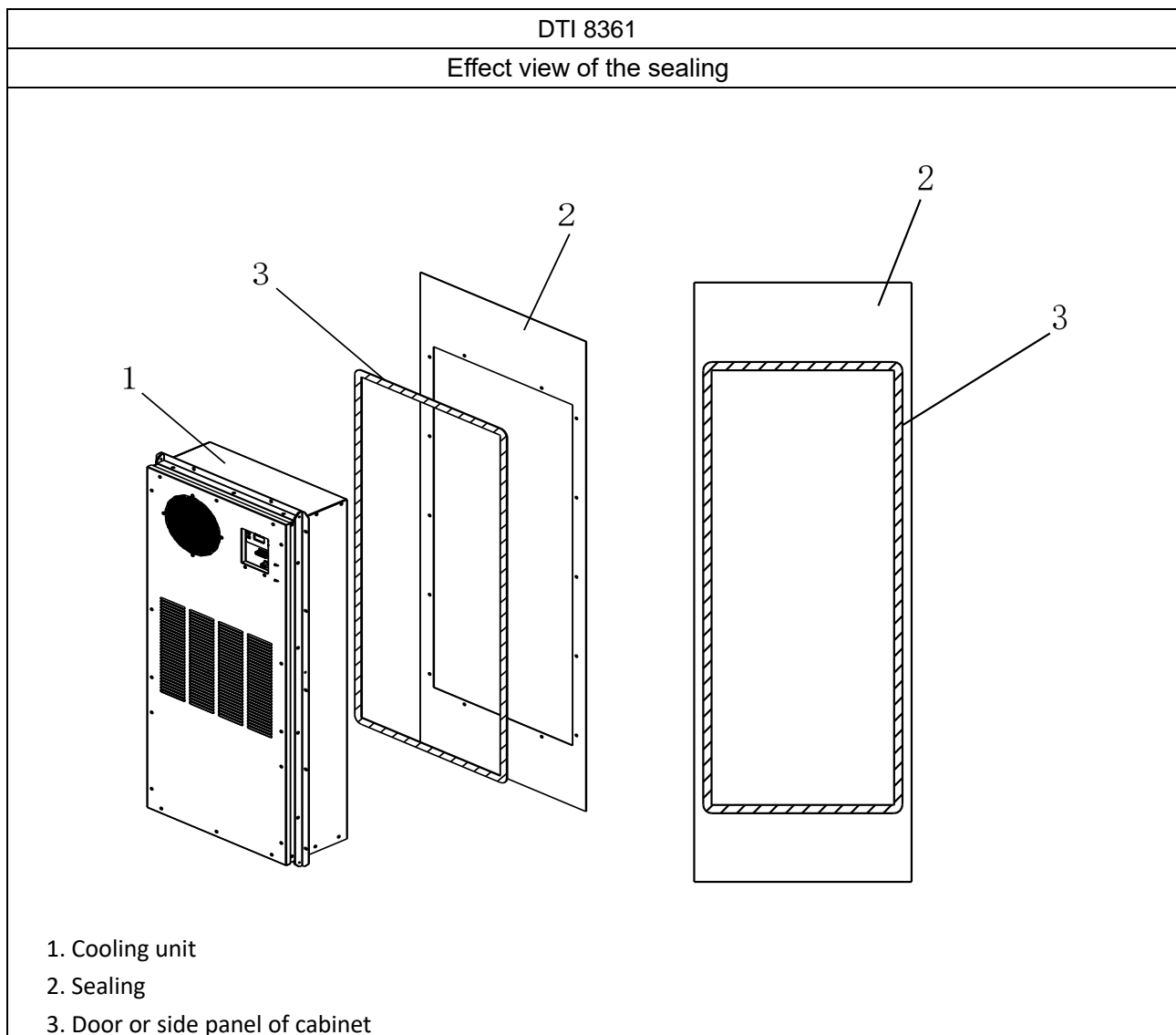

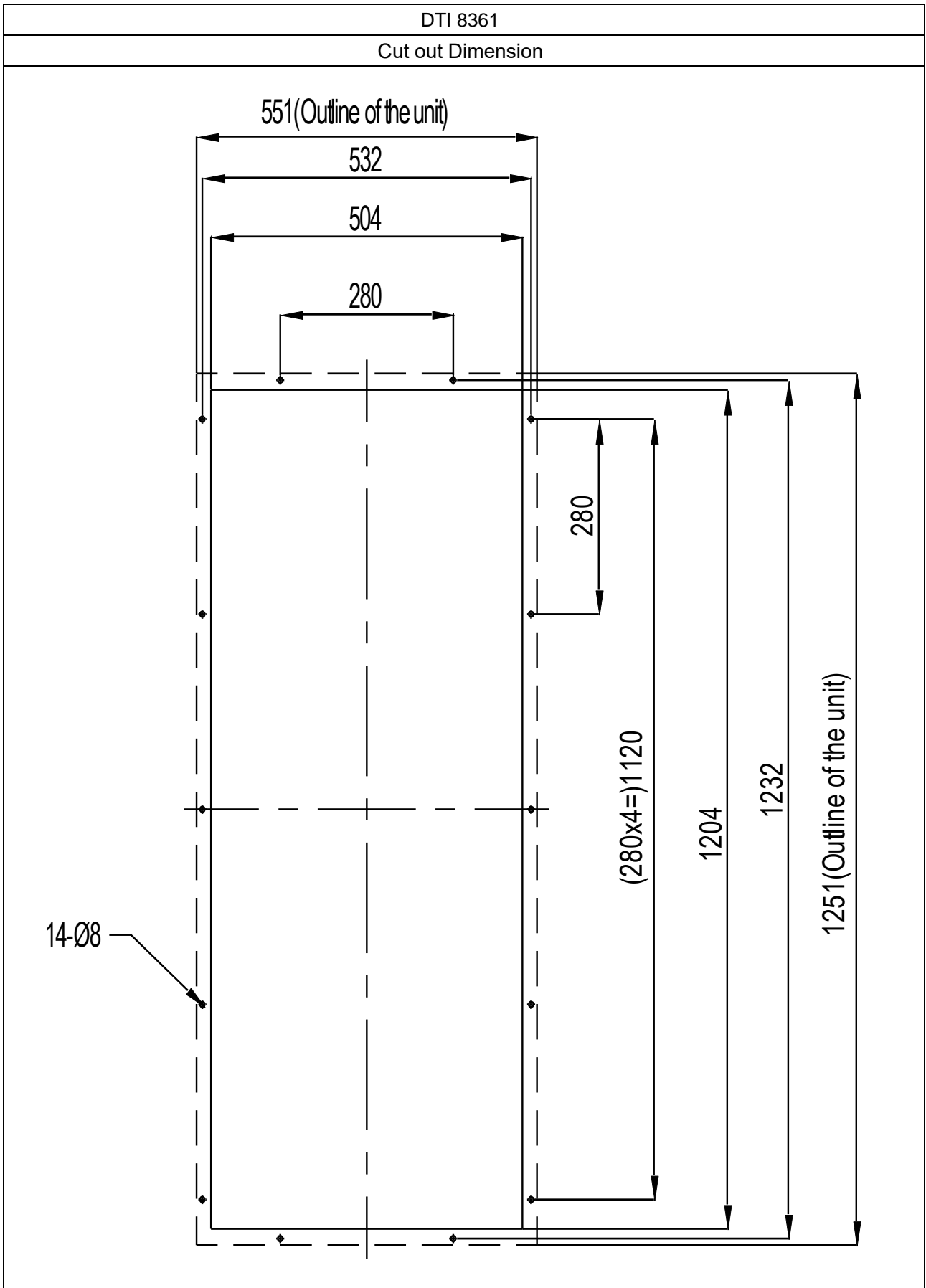

8.4 Airflow principle

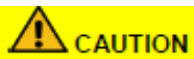
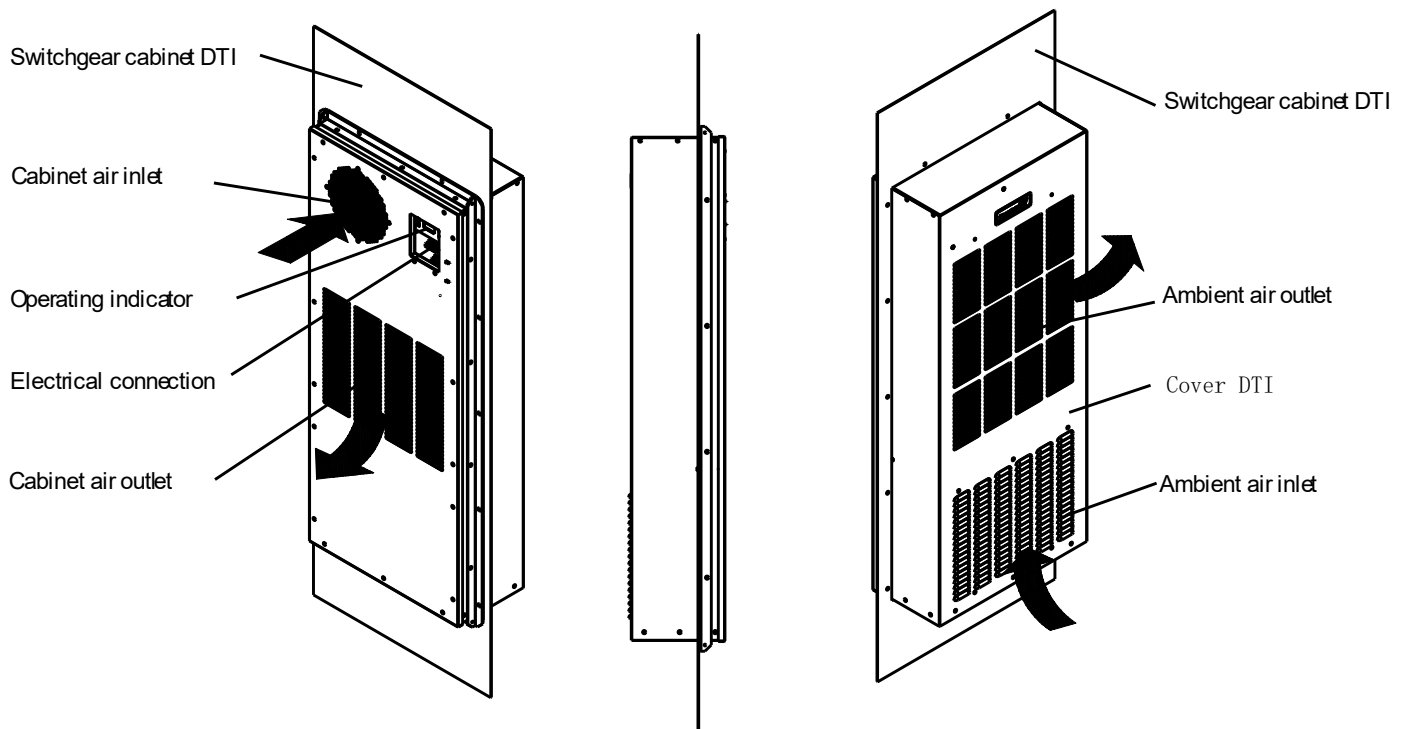

Read this manual completely and carefully before installing the unit.
Prior to mounting, ensure that the clearance of the units to each other and to the wall is at least 200mm; air inlet and outlet are not obstructed on the inside of the enclosure.

8.5 Technical Data

Cooling data		DTI 8361
Cooling capacity at A35/A35 * **	Q ₀	3000 / 3200 W
Cooling capacity at A50/A35 * **	Q ₀	2150 / 2300 W
Refrigerant type*		R 134a
Refrigerant amount*		1420 g
Thermostat setting, (factory set)		+33°C (+91.4°F)
Failure indication: Enclosure internal temp. (factory set)		> +45°C (+113°F)
Ambient air temperature		-40°C (-40°F) . . . +55°C (+131°F)
Enclosure internal temp		+18°C (+64.4°F) . . . +43°C (+109.4°F)
Air volume, external circulation °)		1200 m ³ /h
Air volume, internal circulation °)		1600 m ³ /h
Condensation discharge		Condensate discharge pipe
Noise level (1m)		≤ 68 dB(A)
Electrical data		
Mains frequency		50 / 60 Hz
Operating range		DIN IEC 60038
Rated voltage		230 V
Power consumption *(A35/A35) :	P _{el}	1250 / 1570 W
Current capacity *	I _{nom max}	8,5 / 11,7 A
Starting current *	I _{Start max}	40,0 A
PTC Heater		1000 W @ 0°C
Height X Width X Depth °°)		1251 x 551 x 225 (mm)
Weight		66 kg
Installation attitude		vertical
Unit construction		Standard: Steel
Corrosion protection		Standard:galvanized, electrostatically powder coated (200°C)
Protection system according to EN 60529		IP55 against the enclosure, under correct operating conditions. IP34 against the environment, under correct operating conditions.

* ID Plate Information

** Cooling capacity without filter mats (Option)

°) Free-blowing

°°) Need additional electrical terminal space 40mm

9 Installations

9.1 General

- For effective cooling & ventilation, correct installation & ventilation of the cooling unit is very important.
- The distance must be kept at least 200mm between units or the unit to the wall.
- The cooling unit's electrical connection terminal requires at least 40mm space and the electrical components shall not impede air circulation in the internal cabinet.
- The power supply must be switched off when installing the cooling unit.
- The site of installation must be protected against contamination.

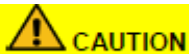

If the cooling unit is mounted on an switch cabinet door, it must be confirmed that hinges can support the additional weight or that the switch cabinet will not topple over when the door is opened.

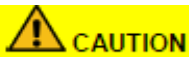

Burrs may damage the switch cabinet. When making a hole on site, a cover sheet must be used to avoid the burrs entering into the cabinet which may damage the electrical components.

9.2 Installation work

The mounting surface of the switch cabinet is to be provided with cutout and holes for air ventilation openings and for securing the unit according to cut-out dimension.

- 1) If the cabinet is not prepared with mounting cutout, please make cut-out on the cabinet ([refer to cut-out dimension](#)), then remove burrs from the cut edge.
- 2) Take out the sealing strip from the attachment bags (Pos. 3), align and stick in the switch cabinet (Pos. 2)
- 3) Please put in place of the flat gasket, spring washer, nut (Pos. 4, 5, 6) on the inside of the cabinet and lock the cooling unit tightly.
- 4) Clamp the cable as shown in the connection diagram (see backside of unit) to the plug, (component pack), and connected to the cabinet air conditioner ([see Section 9.3](#)).

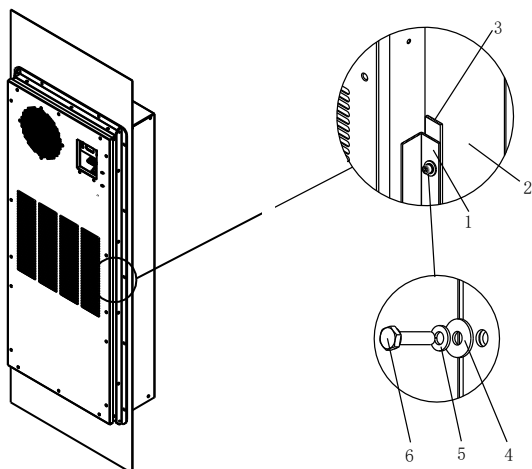

1. Cooling unit DTI
2. Switch cabinet wall or door
3. Sealing
4. Flat gasket
5. Springs shim
6. Nuts

9.3 Electrical connection

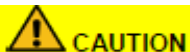

- The cooling unit must be connected to the mains by means of a disconnecting device with a contact gap of at least 3mm when switch off.
- No temperature regulator is allowed to be series-connected to the cooling unit up-stream feed.
- The fuse as indicated on the name plate must be series-connected as line protection.
- Power connection and repairs, if applicable, may only be carried out by authorized trained electricians.

Power supply connection:

Both mains voltage and frequency must correspond to the nominal values indicated on the name plate of the cooling unit. There are more labels with signs and explanation on the housing of the unit. Read them carefully before connection.

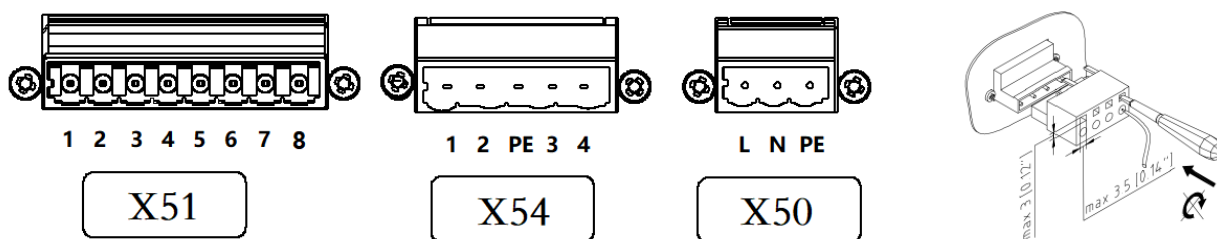

Port name	Serial number	Symbol	Definition	Cable size
X50	L	L	Mains "L"	Max 2.5mm ² / AWG14
	N	N	Mains "N"	
	PE	PE	Mains "PE"	
X54	1	/	Alarm signal	Max 1.0mm ² / AWG18
	2	/		
	PE	PE	PE	
	3	/	Door contact control	
4	/			
X51	1	/	Power fault signal	Max 1.0mm ² / AWG18
	2	/		
	3	AO1 +	4~20mA Temperature output "+"	
	4	AO1 -	4~20mA Temperature output "-"	
	5	AO2 +	4~20mA Humidity output "+"	
	6	AO2 -	4~20mA Humidity output "-"	
	7	RXD+	RS485 Communication interface "+"	
8	TXD -	RS485 Communication interface "-"		

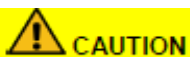

The supply voltage and frequency must conform to the values indicated on the nameplate, please carefully

check the electrical label on the machine. If the voltage is too high, it may cause damage to the device; The rated voltage of general air conditioners is 230V

Communication Connection:

The unit supports standard Modbus protocol and RTU mode. The factory default communication address: "1", Bau: "9.6Kbps". RS485 allows 32 units to be connected together as a network. In order to link cooling units, following methods shall be taken:

- Connect the shield sheath to earth terminal, a 120ohm matching resistance should be connected to the last cooling unit.
- In order to avoid any destructive effect, should use twist-pair cable with protective sheath.
- Make sure that no strong interference sources surrounding the communication wires. Connect each cooling unit's (+, -, PE) terminal correctly.

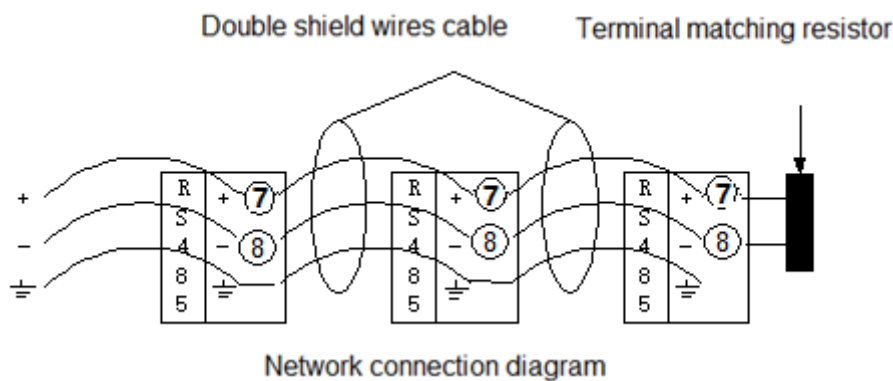

WARNING

Please follow the wiring diagram, the wrong wiring will cause the device to not work properly or even damage!

10 Operating condition

- The voltage must be within $230v \pm 10\%$ of the value indicated.
- The frequency must be within $\pm 3\text{Hz}$ of the value indicated.
- Ambient temperature must be below 55°C .
- Use the unit such that the cooling capacity suits the actual demand.
- Use genuine spare parts.

11 Putting into operation and function

Please refer to [section 7](#) for the function and options.

11.1 General remarks

The cooling unit is provided with an electronic control system. Internal temperature is measured by a temperature sensor. The target setting point of the cooling unit can be set through operating display, ([See Appendix II](#)).

The cooling unit is provided with power-on self-test and real-time monitoring function. The cooling unit will generate an alarm when there is a failure during power-on self-test. It makes easier to troubleshoot of before entering working mode.

11.2 Operation display

The cabinet air conditioner is equipped with an operating display. After powering on, the operation display displays the real-time temperature in the cabinet, indicating that the unit is in normal operation mode. In the event of a malfunction or when there is an alarm output, the operating display displays an alarm code, which makes it easier to diagnose cabinet air conditioning faults. ([Refer to section 16 for diagnosis](#))

11.3 Start-up / Test mode

Before power-on, if the door contact is disconnected, the cabinet air conditioner will not start until the door contact is closed, and the cabinet air conditioner will enter the self-test mode, which will not be affected by the external environment. After the cabinet air conditioner is powered on, it will enter the startup mode for about 30s, and then enter the self-test mode for about 120 seconds.

Mode	Time curve	Characteristics
Start-up mode	t=0s-30s	Shows internal temperature
Test mode	t=30s-40s	Internal fan starts up
	t=40s-50s	External fan starts up, Internal fan stops
	t=50s-60s	Power heater starts up External fan stops
	t=60s-90s	Compressor starts up Power heater stops
	t=90s-150s	Internal fan / External fan / Power heater / Compressor starts up

11.4 Door contact

For safety reasons, a door limit switch should be connected to the terminals provided on the cooling unit. (see the wiring diagram on housing cover or refer to [circuit diagram](#)). With the switch in place, when enclosure door is open (thereby opening the switch), all of the motors are turned off with a time lag.

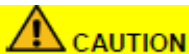

In order to avoid any disruptive influences, it is recommended that a sheathed cable with twisted pair leads be used.

No external voltage is required.

If no door contact switch is used, the connecting contacts are to be bridged. ([see circuit diagram](#))

11.5 Equipment fault







Device fault signal X54—1, 2pin is NC, it closes when power supply is on without alarm, a fault at the cooling unit will open the failure contact and the alarm code will be shown on the display. (See Section 16 for trouble shooting).

Fault signal X51—1, 2pin is NC, it closes when power supply is on properly, failed supply at the cooling unit will open the failure contact and the alarm code will be shown on the display. (See Section 16 for trouble shooting).

The fault contact may be loaded with max 230V, 1A

12 Parameters View and Settings

- Parameters of cooling unit can be monitored and set via operation display (Display code hierarchy see appendix I)
- Cooling unit control system includes control board, operation display.

Sign	Description	Lighting
	Self-check	Self-check
	Cooling	Cooling
	Heat	heater
	Humidity	Dehumidification
	Fan	Running
	Alarm	Alarm

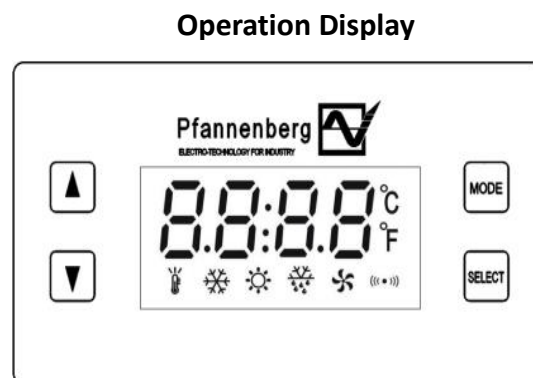

12.1. View Parameters

In the main interface of the operation panel, press and hold the "Select" button for 3s, when the operation display displays "SEE", press the "Select" button again, and then use the "▼" or "▲" keys to cycle through the selection parameters "ts1", "t1", "Hs1", "U", "SC", "add", "bau", "Ao1", "Ao2", "no1", "no2", "no4", "no5", "no6", "no7", "CC", select any code and press the "Select" key to enter the parameter value of the corresponding parameter, and press the "Mode" key to return to the upper menu. Press the "Mode" button continuously under the menu of any operation interface or stand for 3min without any operation, and you can return to the main display interface. See the meaning of the specific code. (Appendix II)

12.2. Parameter setting

- Under the main interface of the operation panel, press and hold the "Select" button for 3s, when the operation display displays SEE, then press the "▼" or "▲" key, select "PASS" and then press the "Select"

key to enter the password input interface, the default display value is 000, you can enter the value by pressing the "▲" key, press the "▼" key to shift the value input, enter the password "666", press the "Select" key to confirm the entry: user first-level menu.(The first-level menu and the corresponding second-level menu are shown in [Appendix I](#))

- First -level menu operation: You can use the "▲" or "▼" keys to cycle through the temperature "tP", humidity "Hr", Modbus "Co", alarm status "AL", power supply "PO", forced mode "Sta", device status "dg", analog "Ag", enable "En", historical alarm record "HS". When the corresponding first-level menu is selected, press "Select" to enter the corresponding second-level menu, and use the "▲" or "▼" keys to cycle through the corresponding second-level menu to observe each parameter.
- Operation of the second-level menu: After entering the corresponding secondary menu, press the "Select" key to view or set its parameter values. If you modify the value, you need to press the "▲" key to enter a new value, press the "▼" key to shift the value, enter the appropriate value and press the "Select" key again to save and modify; If you don't need to modify the corresponding menu parameter value, just press the "Mode" key to cancel the operation and return to the upper menu; Press the "Mode" key to return to the upper menu during any operation, and press the Mode button continuously in the middle button or wait for 3min without any operation, it will automatically return to the main display interface. ([Appendix II](#))

Operation sample: Change“t1” Setting:

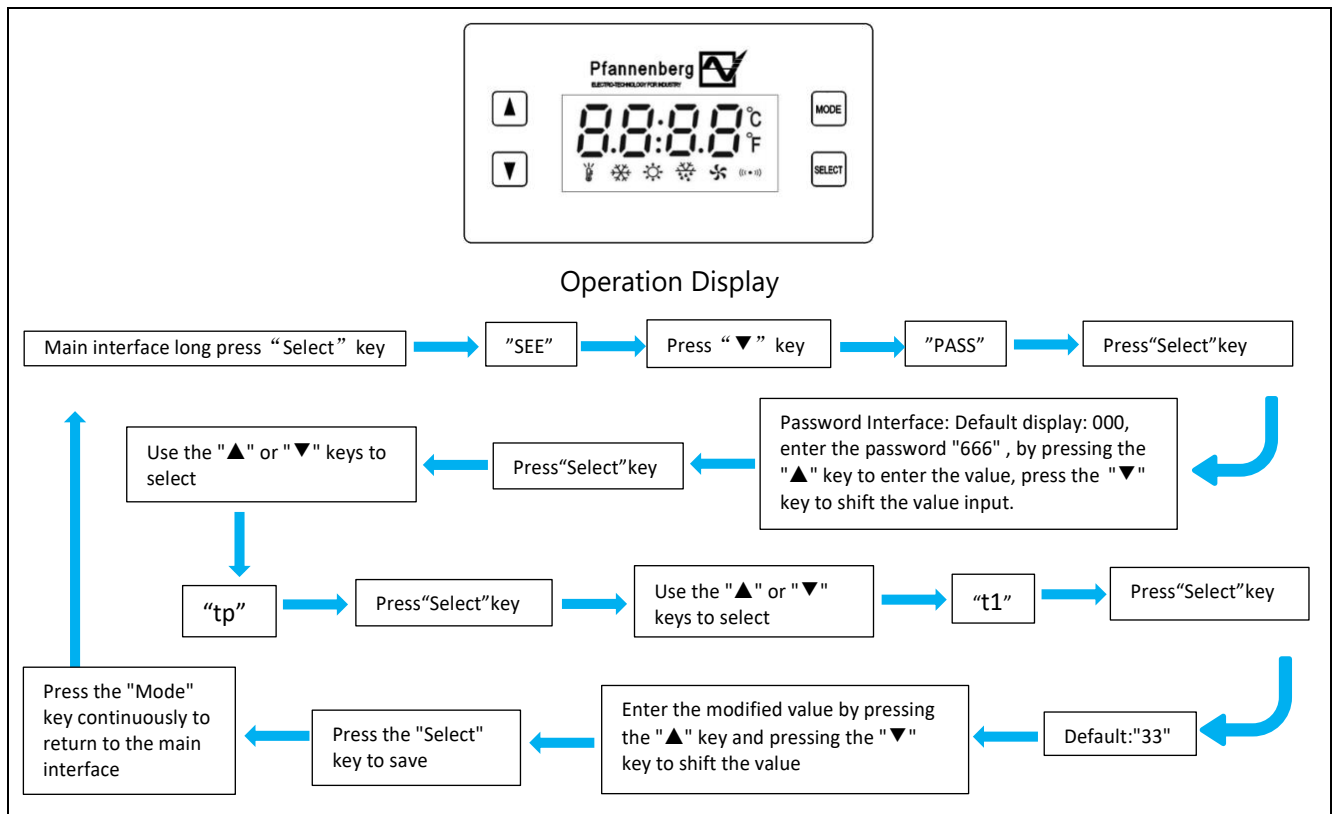

Communication address “add” setting:

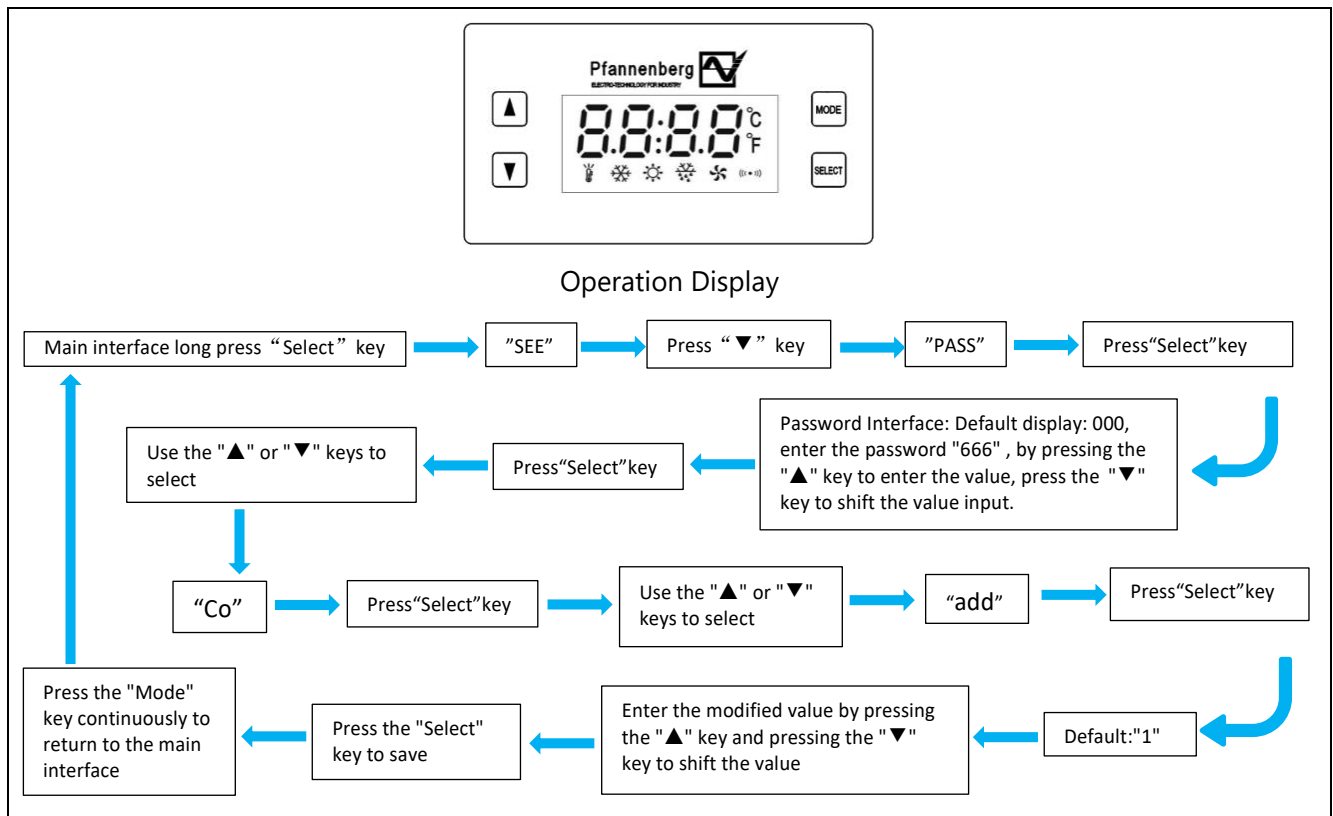

- In the example, if you need to cancel the operation or return to the upper menu during any operation, you only need to press the "Mode" button, and if you press the "Mode" button continuously or stand for 3 minutes without any operation, you will return to the main display screen.
- For the modification of other parameters involved in the secondary menu ([appendix I](#)), please refer to the example "t1", "add" to modify the operation method, and operate the settings after entering the corresponding primary menu.

WARNING

For parameter setting, description and notice shall be observed in [appendix II](#). Improper settings will cause the machine to not work properly

CAUTION

Under any operation screen, when no any key is triggered, return to back the main interface after 180 seconds .

After the parameter is successfully modified, you need to restart the device, the modified value will take effect.

12.3. Reset factory default setting

Under the main interface of the operation panel, press and hold the "Select" button for 3s, when the operation display displays SEE, then press the "▼" or "▲" key to select the dEFu menu, and then press the "Select" key to enter the password input interface, the default display value is 000, you can enter the value by pressing the "▲" key, press the "▼" key to shift the value input, enter the password, press the "Select" key to confirm the

completion of the factory reset, and press the "Mode" key continuously to return to the main interface.

At any parameter interface, press "Mode" to go back to previous menu until home page.

At any interface, system returns back to home page without pressing any button for 180s.

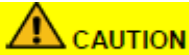

For factory password recovery, please consult our Pfannenberg service team. (www.pfannenberg.com)

After the factory reset is reset, please power off and restart the cabinet air conditioner. The device provides a maximum of 200 historical alarm records, and when the factory settings are restored, the historical alarm will also be cleaned up accordingly.

12.4. Remote settings

The cooling unit has two RS485 serial communication connection ports, and supports standard Modbusprotocol RTU mode. (See [appendix II](#))

The cooling unit can be remotely monitored and controlled. For further support you may ask our service team for technical solution.

13 Cleaning and Maintenance



Please cut off the cooling unit's power before carrying out any cleaning or maintenance operation.

13.1 Cleaning

The operation efficiency and reliability of the equipment will be improved by periodic cleaning and maintenance, call our service team for further service cooperation.

Pay special attention to the following instructions:

- Use a soft brush or compressed air (Medium pressure to avoid damage to the fins).

Proceed as follows:

- 1) Cut off power supply to the cooling unit.
- 2) Remove the external cover.
- 3) Clean the air ventilation channel.
- 4) Clean the external fan.
- 5) Clean the exchangers.
- 6) Put back the external cover
- 7) Connect the power and observe the test mode to make sure the equipment is running properly.

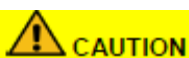

Avoid electrical shock

Prevent damage to the heater exchangers

Don't use any pointed or Sharp-edged objects.

To prevent damage to the electrical connection on the inside of the covering hood, the electrical plug-in connections must be carefully removed before cleaning and reconnected after.

13.2 Maintenance

During equipment malfunction, a fault alarm code will be shown on the display. Please refer to the trouble shooting guide below to identify & rectify the fault. ([See section 16](#))

After every service & maintenance, please complete the power-on self test process to ensure that the cooling unit is functioning properly.

14 When not in used

Please switch off the cooling unit when it is not in use for a longer period of time. Ensure that non-authorized persons cannot start the cooling unit.

When the cooling unit is no longer needed, it must be disposed of by authorized personnel in accordance with all applicable environmental protection regulations. ([See section 4](#))

15 Recycle

- Dismantling must be carried out by a suitably qualified professional technician; It is also important to be aware of local rules and regulations.
- All parts (e.g., refrigerants, oils, metals, electronic components) must be recycled, reused or discarded. Please respect local and national regulations and contact your local garbage collection industry if necessary.
- When discarding the above garbage, it is necessary to consult a professional garbage removal company, which will issue a garbage removal certificate, which must be filed; When discarding, please consult our Pfannenberg service team (www.pfannenberg.com/disposal)

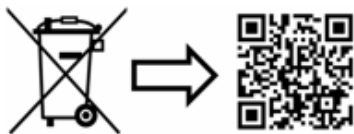

16 Trouble shooting

In spite of careful maintenance, the equipment may still have a failure sometime in the future. The real-time self-check function can diagnose the failure.

If a fault occurs, the display will show the relevant alarm code, Below is the trouble shooting guide .

Alarm codes list:

Alarm code	Description	Trouble shooting method
AL01	ts 1 alarm	1) Check sensor of Pb1 2) Check the connection cable 3) Make sure the connection is correct
AL02	ts 2 alarm	1) Check sensor of Pb2 2) Check the connection cable 3) Make sure the connection is correct
AL03	ts 3 alarm	1) Check sensor of Pb3 2) Check the connection cable 3) Make sure the connection is correct
AL04	ts 4 alarm	1) Check sensor of Pb4 2) Check the connection cable 3) Make sure the connection is correct
AL05	Humidity sensor malfunction	1) Check the humidity sensor 2) Check the connection cable 3) Make sure the connection is correct
AL06	Cabinet door open	1) Check door switch 2) Make sure the connection is not loose 3) Make sure the connection is correct
AL07	The system pressure is too high	1) Check whether the external air duct is blocked 2) Check whether the fan is running normally 3) Check whether the condenser is dirty and blocked, and clean the outer surface of the condenser. 4) Check the pressure sensor cable
AL08	High temperature	1) If alarm AL06, cooling until stops running; 2) Make sure internal fan and external fan work normally; 3) Make sure compressor work normally; 4) Check condenser if it's dirty or blocked; 5) Check internal air outlet is not blocked and the air duct is smooth; 6) Check heat load. 7) Check the setting value of the "Overtemperature Alarm Difference" parameter is reasonable
AL09	Low temperature alarm	1) Check if the heater is activated 2) Check whether the internal fan is running normally 3) Check whether the internal control setting parameters are within a reasonable range
AL10	High humidity alarm	1) If the humidity is too high, check the cabinet seal. 2) Check the humidity sensor wiring
AL11	Low humidity alarm	1) The humidity is too low 2) Check the humidity sensor wiring
AL12	Compressor failure	1) Check the compressor and connecting lines 2) Check whether the refrigeration system is normal 3) Check whether the parameter settings are within a reasonable range
AL13	The evaporator is dirty or the internal circulation tuyere is blocked	1) Check whether the internal circulation air duct is blocked 2) Check whether the surface of the evaporator is clean
AL14	Frosting of the evaporator	1) Check the internal heat load 2) Check whether the internal fan is running normally 3) Check whether the inner circulation air duct is blocked 4) Check whether the set parameters are within a reasonable range
AL15	Power failure	1) Check the power supply voltage of the device

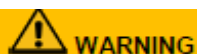
WARNING

Non-authorized personnel should not repair the equipment.

17 Warranty Conditions

Warranty becomes null and void:

- In case of improper usage of the unit, noncompliance with operating conditions or non observance of instructions;
- If operated in rooms in which corrosives or acids are present in the atmosphere;
- In case of damage caused by contaminated or jammed air filters;
- If a non-authorized person interrupts the cooling circulation, modifies the unit or changes the serial number;
- In case of damage caused by transport or by accidents;
- For the exchange of parts by unauthorized companies;

In order to maintain your warranty rights please observe the following when returning the unit;

- Enclose an exact description of the fault in the shipping package.
- Enclose proof of delivery (delivery note or copy of invoice).
- Return the unit together with all accessories;use the original packaging or packaging of equivalent quality, send the unit freight prepaid and covered by an adequate transport insurance. Observe the hints on transport mentioned [in section 2](#)

Appendix I

Display code hierarchy						
Level 1 code	Level 2 code	Description	Level 1 code	Level 2 code	Description	
(tP) Temperature	ts1	Air inlet of the temperature	(Sta) Force Mode State	AU	Internal reservation, do not modify the parameters, otherwise the device will not work properly	
	ts2	Air outlet of the temperature		CL		
	t1	Energy-saving temperature setting		Ht		
	t2	Energy-saving temperature setting		FA		
	t5	Heat-start temperature setting		SD		
	t6	Heating stop offset		DH		
	t8	The temperature in the cabinet is too high		d3		High pressure switches
	t9	The temperature in the cabinet is too low		d4		Door switches
(Hr) Humidity	HS1	Humidity in the cabinet	(dg) Switching Quantity	StS	The working status of the device	
	rh1	Dehumidification opening point		no1	Internal fan	
	rh2	Dehumidification speed		no2	External fan	
(Co) Communication	add	Address		no4	Heater	
	baU	Baudrate		no5	Compressor	
(aL) Alarm	no6	Fault alarm		(ag) Analog	Ao1	Temperature analogue output
	no7	Power signal		Ao2	Humidity analogue output	
(Po) Power Supply	U	Voltage		(en) Enable	Eco	Internal reservation, do not modify the parameters, otherwise the device will not work properly
	Sc	Current	CC			
(hS) Historical Alerts	E1-E200	Alarm code			Edh	

Appendix II

Communication address

Address (Decimal)	Display code	Value property	R/W	Command code	Description	Default	Range of values	Unit	Data description
1	ts1	Analog	R	03	Air inlet of the temperature			°C	Data= Actual value*10
2	ts2	Analog	R	03	Air outlet of the temperature			°C	Data= Actual value*10
3	ts3	Analog	R	03	Evaporation temperature			°C	Data= Actual value*10
4	ts4	Analog	R	03	Condensing temperature			°C	Data= Actual value*10
5	Hs1	Analog	R	03	Humidity in the cabinet			%	Data= Actual value*10
6	Ao1	Analog	R	03	Temperature analogue output current			mA	Data= Actual value*10

7	Ao2	Analog	R	03	Humidity analogue output current			mA	Data= Actual value*10
8	U	Analog	R	03	Voltage			V	Data= Actual value*10
9	SC	Analog	R	03	Current			A	Data= Actual value*10
10	t1*	Analog	R/W	03/06	Internal return air temperature	33	20-45	°C	Data= Actual value*10
12	t3	Analog	R/W	03/06	Cooling stop offset	2	1-10	°C	Data= Actual value*10
14	t5	Analog	R/W	03/06	Heat-start temperature setting	10	-40-35	°C	Data= Actual value*10
15	t6	Analog	R/W	03/06	Heating stop offset	5	2-15	°C	Data= Actual value*10
16	t7	Analog	R/W	03/06	Dehumidification intermediate variables	5	1-10	°C	Data= Actual value*10
17	t8*	Analog	R/W	03/06	The temperature in the cabinet is too high	45	25-70	°C	Data= Actual value*10
18	t9	Analog	R/W	03/06	The temperature in the cabinet is too low	0	-20-20	°C	Data= Actual value*10
20	rH1	Analog	R/W	03/06	Dehumidification opening point	80	70-99	%	Data= Actual value
21	rH2	Analog	R/W	03/06	Dehumidification speed	20	10-30	%	Data= Actual value*10
22	rHH	Analog	R/W	03/06	Humidity is too high	85	60-100	%	Data= Actual value
23	rHL	Analog	R/W	03/06	Humidity is too low	20	0-30	%	Data= Actual value
24	add*	Integer	R/W	03/06	Address	1	1-255		Data= Actual value
25	baud*	Integer	R/W	03/06	Baudrate	3	0-5		0=1200,1=2400,2=4800,3=9600,4=19200,5=38400
32	no6	Boolean	R	03	Fault alarm				0: No alarm, 1: Alarm
33	no7	Boolean	R	03	Power signal				0: No alarm, 1: Alarm
42	d3	Boolean	R	03	High pressure switches				0= Stop ,1= Running
43	d4	Boolean	R	03	Door switches				0= Stop ,1= Running
44	STS	Boolean	R	03	The working status of the device				0= Stop ,1= Running
45	no1	Boolean	R	03	Internal fan				0= Stop ,1= Running
46	no2	Boolean	R	03	External fan				0= Stop ,1= Running
47	no3	Boolean	R	03	Retain				0= Stop ,1= Running
48	no4	Boolean	R	03	Heater				0= Stop ,1= Running
49	no5	Boolean	R	03	Compressor				0= Stop ,1= Running
55	AL 1	Boolean	R	03	ts1 Alarm				0: No Fault , 1 : Fault
56	AL 2	Boolean	R	03	ts2 Alarm				0: No Fault , 1 : Fault
57	AL 3	Boolean	R	03	ts3 Alarm				0: No Fault , 1 : Fault
58	AL 4	Boolean	R	03	ts4 Alarm				0: No Fault , 1 : Fault
59	AL 5	Boolean	R	03	Humidity sensor malfunction				0: No alarm ,1: Alarm
60	AL 6	Boolean	R	03	Door access control alarm				0 : Door open 1 : Door close
61	AL 7	Boolean	R	03	Alarm if the system pressure is too high				0: No alarm, 1: Alarm
62	AL 8**	Boolean	R	03	High temperature alarm				0: No alarm, 1: Alarm
63	AL 9	Boolean	R	03	Low temperature alarm				0:No alarm, 1: Alarm
64	AL 10	Boolean	R	03	High humidity alarm				0: No alarm, 1: Alarm
65	AL 11	Boolean	R	03	Low humidity alarm				0: No alarm, 1: Alarm
66	AL 12	Boolean	R	03	Compressor failure alarm				0: No alarm ,1: Alarm
67	AL 13	Boolean	R	03	Alarm for dirty blockage of evaporator or blockage of internal circulation tuyere				0: No alarm , 1: Alarm
68	AL 14	Boolean	R	03	TS3 low temperature alarm				0: No alarm, 1: Alarm
69	AL 15	Boolean	R	03	The power supply voltage is faulty				0: No alarm, 1: Alarm

74	ALARM	Integer	R	03	Real-time warnings				Data= Actual value
75	HISAL1	Integer	R	03	The most recent historical alarm				Data= Actual value
76	HISAL2	Integer	R	03	The next historical alarm				Data= Actual value
79	HISAL200	Integer	R	03	200th Historical Alert				Data= Actual value

CAUTION

* The cabinet cooler has a 2°C hysteresis, the default internal set temperature is 33°C, the refrigeration starts when the internal temperature is higher than 35°C, and the refrigeration stops when the internal temperature is below 31°C. It is not advisable to modify other parameters, incorrect modifications will cause the machine to not work.

** By default, when the internal temperature is higher than 45°C, the device will generate a high temperature alarm, and if the temperature drops to within "t1" + 5°C, the high temperature alarm will disappear. Please set the alarm temperature to be at least 5°C higher than the temperature set in the cabinet

*** The default heater setting is to start when the internal temperature is below 5°C and stop heating when the internal temperature is above 10°C

WARNING

All the parameters in the attached table should not be changed by mistake, and failure to follow the instructions of Pfannenberg will result in the invalidation of the product warranty clause.

All parameters not mentioned are reserved for Pfannenberg, and the final use and interpretation rights belong to Pfannenberg

All parameters not mentioned should not be changed without authorization, otherwise the device will not work normally.

百能堡电气科技（苏州）有限公司

中国苏州工业园区杏林街 108 号

邮编：215026

电话：+86-512-6287-1078

传真：+86-512-6287-1077

邮箱：service@pfannenbergn.cn

<http://www.Pfannenbergnchina.com>

Pfannenbergn Electro-Technology (Suzhou) Co.,Ltd.

No. 108 Xinglin street, SIP, Suzhou 215026, Jiangsu, P.R.C

Tel: +86-512-6287-1078

Fax: +86-512-6287-1077

e-mail: service@pfannenbergn.cn

